

THE
COMPOSITION OF EXPIRED AIR
AND ITS
EFFECTS UPON ANIMAL LIFE.

BY

J. S. BILLINGS, M.D., S. WEIR MITCHELL, M.D.,
AND D. H. BERGEY, M.D.

1
c



Nº 1452

612.131

Hygiene

2.04.03.00-6

591.1

B598c

SMITHSONIAN CONTRIBUTIONS TO KNOWLEDGE.

— 989 —

Hodgkins Fund.

THE
COMPOSITION OF EXPIRED AIR
AND ITS
EFFECTS UPON ANIMAL LIFE.

BY

J. S. BILLINGS, M.D., S. WEIR MITCHELL, M.D.
AND D. H. BERGEY, M.D.

CITY OF WASHINGTON :
PUBLISHED BY THE SMITHSONIAN INSTITUTION.
1895.

COMMISSION TO WHOM THIS MEMOIR
HAS BEEN REFERRED.

HORATIO C. WOOD.
WILLIAM HENRY WELCH.
CHARLES SEDGWICK MINOT.

ADVERTISEMENT.

The present memoir is the result of a series of investigations made by Doctors J. S. Billings and S. Weir Mitchell, assisted by Doctor D. H. Bergey, under a grant from the Hodgkins Fund of the Smithsonian Institution, for the purpose of determining the nature of the peculiar substances of organic origin contained in the air expired by human beings, with special reference to the practical application of the results obtained to problems of ventilation for inhabited rooms.

In accordance with the rule adopted by the Smithsonian Institution the work has been submitted to a committee, in the present instance consisting of Doctor H. C. Wood, Professor William H. Welch, and Professor Charles S. Minot, and having been recommended by them for publication, it is herewith presented in the series of Contributions to Knowledge.

S. P. LANGLEY,

SECRETARY.

WASHINGTON, *November, 1895.*

THE COMPOSITION OF EXPIRED AIR, AND ITS EFFECTS UPON ANIMAL LIFE.

REPORT ON THE RESULTS OF AN INVESTIGATION MADE FOR THE SMITHSONIAN INSTITUTION UNDER THE PROVISIONS OF THE HODGKINS FUND.

BY J. S. BILLINGS, M.D., S. WEIR MITCHELL, M.D., AND D. H. BERGEY, M.D.

In May, 1893, a grant was made from the Hodgkins Fund to Drs. John S. Billings and S. Weir Mitchell, "for the purpose of conducting an investigation into the nature of the peculiar substances of organic origin contained in the air expired by human beings, with special reference to the practical application of the results obtained to problems of ventilation for inhabited rooms."

For a number of years prior to 1888 the prevailing view among physicians and sanitarians had been that the discomfort and dangers to health and life which had been known to exist, sometimes at least, in unventilated rooms occupied by a number of human beings, were largely or entirely due to peculiar organic matters contained in the air expired by these persons, and that the increase in carbonic acid due to respiration had but little effect in producing these results, its chief importance being that it furnished a convenient means of determining the amount of vitiation of the air. Recently, however, several experimenters have concluded that the organic matters in the exhaled breath are not harmful, at all events to animals, and the main object of the proposed investigation was to determine the correctness of these conclusions. For this purpose a scheme of experimentation was prepared by Drs. Billings and Mitchell, which scheme has been carried out in the Laboratory of Hygiene of the University of Pennsylvania, by Dr. D. H. Bergey, assisted at times in the chemical work by Dr. Hill S. Warwick, and in some of the pathological investigations by Dr. Ingersoll Olmsted, and under the general supervision of Dr. A. C. Abbott, First Assistant in the Laboratory, to whom thanks are due for many valuable suggestions during the progress of the work. From time to time Dr.

Bergey's notes on the results of his experiments have been submitted to Drs. Billings and Mitchell, who have suggested modifications or new experiments as the work progressed. This report is based on these notes, and accompanying tables and charts, given in the Appendix.

The effects produced on animals and men by an atmosphere contaminated with their exhalations, and with particulate matters derived from their bodies or their immediate surroundings, may be divided into acute and chronic. The acute effect may be death in a few minutes or hours, as shown by the results observed in the Black Hole of Calcutta, in the steamer *Londonderry*, and in many of the experiments referred to in this report, or it may be simply great discomfort, especially in those unaccustomed to such conditions.

The chronic effects include the favoring of the action of certain specific causes of disease commonly known as contagions, if these are present, and perhaps also a general lowering of vitality.

The statistical evidence collected by the English Barrack and Hospital Commission (1) * as to the effects of insufficient ventilation upon the health of soldiers in barracks, published in 1861, showed that men who live for a considerable portion of their time in badly ventilated rooms have higher sickness and death-rates than have those who occupy well ventilated rooms, other conditions being the same; and this has also been found to be true with regard to monkeys and other animals. It is evident, however, that in a room occupied by animals or men there are many sources of impurity besides the exhaled breath, and it is still a question whether the expired air contains substances injurious to life, excluding carbonic acid.

The widely divergent results obtained and conclusions reached by different investigators during the last ten years as to whether the exhaled breath of men and animals contains a peculiar volatile organic poison, have made it desirable to repeat and vary such experiments in order, if possible, to settle this important point. The chemical analyses of the air of overcrowded rooms, and the experiments upon animals with various proportions of carbonic acid, made by many investigators, indicate that the evil effects observed are probably not due to the comparatively small proportions of carbonic acid usually found under such circumstances.

It was shown by Leblanc (2), in 1842-43, that an animal can breathe an atmosphere containing as much as 30 per cent. of carbonic acid for three-quarters of an hour, provided that the percentage of oxygen was 70, and then quickly recover from the depression induced by this mixture after removal to the normal atmosphere. He also demonstrated that under the conditions in which the quantity of

* The numbers in parentheses refer to the bibliographical list appended to this report.

carbonic acid rises perceptibly in theatres, etc., the reduction of oxygen is quite insignificant, and that the proportion rarely falls below 20 per cent.

Regnault and Reiset, (3), in 1849, also found that when sufficient oxygen is supplied to an atmosphere quite rich in carbonic acid, an animal can still live in it. Friedländer and Herter (4) found that the breathing of an atmosphere containing 20 per cent. of carbonic acid for an hour produced no symptoms of depression, but caused stimulation of the respiratory centres and an increased activity of the heart.

Claude Bernard (5), in 1857, experimented with animals confined in atmospheric air and in mixtures both richer and poorer in oxygen than atmospheric air. A small bird placed in a bell glass of a little more than two litres' capacity, containing a mixture of 13 per cent. carbonic acid, 39 per cent. oxygen, and 48 per cent. of nitrogen, died in two and one-half hours. He demonstrated that carbonic acid is not poisonous when injected under the skin of animals—as much as one litre injected under the skin of a rabbit producing no ill effects. No ill effects followed the injection of the gas into the jugular vein and into the carotid artery. An atmosphere of equal parts of oxygen and nitrogen had no effect upon an animal confined in it, while an atmosphere composed of equal parts of carbonic acid and of oxygen produced immediate death in the animal placed in it. He explains the poisonous effects of carbonic acid when respired to be due to the fact that it deprives the animal of oxygen. Similar results were reported by Valentin (6) and by Paul Bert (7).

Richardson, in 1860-61, (8), found that a temperature much higher or lower than 20° C. had the effect of shortening very considerably the lives of animals confined in an unventilated jar, and that these effects were more marked when the animals were confined in an atmosphere richer in oxygen than air, in which case he found that by passing electric sparks from a frictional machine through the fatal air (having previously deprived it of its carbonic acid) it was again made capable of supporting life, from which he concluded that the oxygen is "devitalized" during respiration, and that the electric spark has the faculty of revitalizing it.

Von Pettenkofer, in 1860-63, (9), showed that the symptoms observed in crowded ill-ventilated places were not produced by the excess of carbonic acid, nor by a decrease in the proportion of oxygen in the air; neither of these being sufficient in our dwellings, theatres, etc., to produce toxic effects. He did not believe that the impure air of dwellings was directly capable of originating specific diseases, or that it was really a poison in the ordinary sense of the term, but that it diminished the capability of withstanding the influence of disease-producing agents.

cies on the part of those continually breathing such air, and laid down the rule, which has been accepted and taught by sanitarians for thirty-five years, that the proportion of carbonic acid in the atmosphere of inhabited places affords a safe indication as to the amount of the other impurities resulting from respiration and other exhalations from the bodies of the occupants.

Hammond, in 1863, (10), reported experiments in which he sought to remove the carbonic acid and moisture, and to supply fresh air as fast as it is needed to take the place of the carbonic acid removed, thus leaving the "organic matter" to accumulate in the vessel. For this purpose he confined a mouse in a large jar, in which were several sponges saturated with baryta-water, by which the carbonic acid was removed as fast as formed. Fresh air was supplied as fast as required by means of a tube communicating with the bell jar and closed by water in the bend of the tube, which acted as a valve. As the air in the bell glass was rarefied by respiration and absorption of the carbonic acid, fresh air flowed in from without, while the arrangement of the tube prevented the air of the bell glass from passing out. The watery vapor exhaled by the animal was absorbed by two or three small pieces of chloride of calcium. The mouse died in forty minutes. The observation was repeated many times, and death ensued invariably in less than an hour. On causing the vitiated air to pass through a solution of permanganate of potash the presence of organic matters in large quantity was demonstrated.

Ransome, in 1870, (11), reported a series of very interesting investigations upon "Organic Matter of Human Breath in Health and Disease." By condensing the aqueous vapor of the human breath and analyzing it by the Wanklyn and Chapman method, he found that "in ordinary respiration about 0.2 g. of organic matter is given off from a healthy man's lungs in 24 hours," while in the air expired by persons affected with certain diseases, he found great variations in the amount of organic matter, the amount being greatest in a case of phthisis complicated with Bright's disease.

Smith (12) employed a lead chamber in his investigations upon the question whether human lungs give off any poisonous agent other than carbonic acid. He found the pulse to fall from 73 to 57 beats per minute, and the number of respirations to rise from 15.5 to 24, as the carbonic acid in the atmosphere increased from .04 to 1.73 per cent. during four hours. When the proportion of carbonic acid rose to 3 per cent. there appeared great weakness of the circulation with slowing of the heart's action, and great difficulty in respiration. He believed that these results should be attributed to other conditions rather than to the excess of carbonic acid, because he found later that it was only when lamps became dim in an atmosphere

—indicating a proportion of about 10 per cent. of carbonic acid present—that the respiration became difficult.

Seegen and Nowak, in 1879, (13), believed they had demonstrated the presence of poisonous organic matter in the expired breath, but the quantity found was so small that they failed to determine its exact nature and properties.

Hermans, in 1883, (14), was unable to detect any organic matter in the atmosphere of a tin cage in which several persons had been confined for a number of hours, and found that an atmosphere containing from 2 to 4 per cent. of carbonic acid and 15 per cent. of oxygen was not toxic.

Brown-Séguard and d'Arsonval, in 1887, (15), reported that the air expired by men and dogs in a state of health has the power of producing toxic phenomena; citing three series of experiments on rabbits where such phenomena were observed. In the first series they injected into the vascular system of a rabbit 4 to 6 c. c. of fluid obtained by injecting from 15 to 25 c. c. of pure filtered water into the trachea of a dog. In a second series, from 6 to 7 c. c. of a liquid obtained by condensing the moisture in the exhaled breath of a man, were injected into the aorta, or into a vein, of a rabbit. In the third series from 4 to 6 c. c. of a liquid, obtained by condensing the moisture in the exhaled breath of a tracheotomized dog, were used. The condensed liquid thus obtained was filtered and then injected either into the jugular vein or the carotid artery.

The symptoms observed were dilatation of the pupils and increase of the heart-beat to 240, 280, or even 320 per minute, lasting for several days or even weeks. The temperature remained normal; the respiratory movements were generally slowed; and usually there was observed paralysis of the posterior members. Choleraic diarrhœa was invariably present. Death usually took place in a few days, or at the farthest in four or five weeks. As a rule, it appeared that larger doses caused labored respiration, violent retching, and contracted pupils. A rapid lowering of temperature, 0.5° to 5° C., was sometimes observed. The appearances that presented *post mortem* were much like those observed in cardiac syncope.

They believed they had discovered a volatile organic poison in the exhaled breath and the moisture condensed from it. This poison they believed to be of the nature of an organic alkaloid, or a ptomaine not unlike Brieger's ptomaine (16).

In further reports, in 1888, (17), they state that none of eleven rabbits in which the condensed pulmonary vapor had been injected into the vascular system in doses of 12 to 30 c. c. survived, but of eight rabbits receiving an injection of from 4 to 8 c. c., three were living after the lapse of from four to five weeks, but were then weak. When the fluid was injected under the skin of the thorax and

in the axilla, five out of seven rabbits died rapidly. The results were much the same as when it was injected into the blood. The quantity of the condensed liquid injected in these seven was: 20 c. c. in one case, 25 c. c. in three cases, 31 c. c. in one case, 40 c. c. in one case, and 44 c. c. in another case. After death, considerable congestion of the viscera was noted, especially of the lungs. No appearance of embolism was noted. The brains and its membranes were congested, but without visible lesion. The condensed liquid turns concentrated sulphuric acid yellow. The poison is reduced by ammoniacal nitrate of silver solution as well as by chloride of gold. After boiling in a close vessel it is still toxic, showing that the poison is not a micro-organism. The boiled lung liquid poisons with more rapidity than that which has not been sterilized, and may kill a pigeon and a guinea-pig as well as a rabbit; it may kill by being injected into the rectum or into the stomach; a guinea-pig two months old was killed within twelve hours by an injection of 3 c. c. into the peritoneal cavity. If injected into the lungs this liquid produces rapid congestion followed by true inflammation and red hepatization.

In an experiment with two dogs it was arranged that one breathed ordinary air and the second inhaled air which came from the lungs of the other. The dogs were of the same weight, 15 kilograms. The experiment continued for six hours and forty minutes. No appreciable or immediate consecutive accidents were produced.

In a second experiment the pulmonary liquid was collected from dogs through a tracheotomy tube to exclude impurities furnished by the mouth. The air inhaled was first washed to remove dust. The moisture in the air expired was condensed, and the liquid collected in a flask surrounded by ice. At the moment of injection this liquid was filtered, and was then injected at the temperature of the laboratory, about 12° C. If the animal was kept immovable from 12 to 16 hours, inflammation of the air passages was produced. The liquid of the first hours came from a thoroughly sound lung, and in the later hours from a diseased lung. The two were collected separately and tried separately. For one kilogram of the animal, for each hour, the mean quantity of fluid obtained was 0.38 grammes, varying from 0.28 to 0.48 grammes. It was greater in the beginning and lessened the longer the animal was kept in a fixed position. It was injected into the marginal vein of the ear of a rabbit by means of a syringe, 75 c. c. being injected. When the injection did not exceed 40 to 50 c. c. the time occupied by the injection was from 6 to 15 minutes. Experiments made by injections upon the dog were negative without exception. Experiments made upon the rabbit produced lesions, but the relation between these and the injections was uncertain.

Dastre and Loye, in 1888, (18), reported that they had exposed one dog to

the expired breath of another for six hours without noting any effects. They inoculated animals with the condensed moisture of respiration, as follows :

5 rabbits,	each	33 to 75	c. c. of the fluid.	Results negative.
2 guinea-pigs,	"	5 " 7	" " "	" "
dogs,		30 53		
frogs,				3
2 rabbits,		50 " 190		Died.
A young dog,		30	of water.	"

They found that 50 to 70 c. c. of the condensed fluid of respiration (20 to 35 c. c. per kilo.) could be injected into the veins of the ear of a dog without producing any of the symptoms reported by Brown-Séquard and d'Arsonval. They observed one death during the injection of 190 c. c. (60 c. c. per kilo.), yet by control experiments with water they obtained a more remarkable result—a rapid death from the injection of 30 c. c. of distilled water (25 c. c. per kilo.).

Russo-Giliberti and Alessi, in 1888, (19), reported experiments confirming the results obtained by Dastre and Loye.

Würtz, in 1888, (20), attempted to obtain the "ptomaine" of Brown-Séquard and d'Arsonval from the fluid condensed from expired air. By expiring through a 1 per cent. solution of oxalic acid he obtained, besides ammonia, a volatile organic base which was precipitated by Bouchardet's reagent and by potassio-mercuric iodide. With platinic chloride it formed a double salt, crystallizing in short needles, and a soluble salt with auric chloride. When heated to 100° C. it gave off a peculiar odor. This basic substance, he thought, might be regarded as a leucomaine.

Brown-Séquard and d'Arsonval, in 1889, (21), reported a new form of experiment by means of which they obtained additional evidence in support of their former statements. The new form of experiment consisted in confining animals (rabbits) in a series of metallic cages connected by means of rubber tubing, through which a constant current of air is aspirated. The animal in the last cage of the series receives air that has traversed the entire series of cages, and is loaded with the impurities from the lungs of the animals in the other cages. This animal succumbs, after a time, to the atmospheric conditions present. After another interval of some hours, the animal in the next to the last cage also dies; the first and second animals usually remaining alive. They could not attribute the death of these animals to excess of carbonic acid in the atmosphere of the cages, because they rarely found more than 3 per cent. of this gas in the last jar with small animals, or 6 per cent. with larger animals. On placing absorption tubes containing concentrated H_2SO_4 between the last two cages, the animal in the last cage remained

alive, while that in the cage before it was the first to die. They concluded from these facts, that the death of the animals was produced by a volatile poison, which poison is absorbed by the H_2SO_4 , which thus saves the life of the animal in the last cage.

They stated (22) that any alkali used to absorb carbonic acid from expired air would also change the organic poison, and proposed an apparatus by means of which the organic poison should be supplied to the fresh air entering the jars by volatilizing it from fluid condensed from the expired air.

Von Hofmann-Wellenhof, in 1888, (23), found that when he injected large quantities of the condensed fluid of respiration at 12°C ., instead of at 37°C .—intravenous injection,—a resemblance of the results obtained by Brown-Séguard and d'Arsonval was produced. Under such circumstances he observed muscle weakness, slowing of respiration, fall of temperature, and dilatation of the pupils, though the animals remained alive. He injected 10 rabbits with 6 to 30 c. c. of the fluid warmed to the body temperature, all the results being negative. Three other animals were injected in the jugular vein—one receiving 28 c. c. of the fluid, another 25 c. c. of distilled water, and a third 50 c. c. of distilled water. There was no difference in the symptoms noted in the animals. He noticed symptoms of depression only after injecting 50 c. c., or more, of the fluid. In a series of 17 experiments with inoculations of from 30 to 50 c. c. each of the fluid, in 12 there appeared hæmoglobinuria; 6 of these died. As the result of his experiments, he concluded that the existence of a volatile poison in the expired air of healthy human beings has not been demonstrated by his experiments; this being a direct contradiction of the results of Brown-Séguard and d'Arsonval, as were also those of Dastre and Loye.

Uffelmann, in 1888, (24), found that there was a perceptible increase in organic matter in the atmosphere of a sleeping-room occupied by several persons for some hours, increasing in amount with the length of time the room was occupied.

Lehmann and Jessen, in 1890, (25), collected 15–20 c. c. of condensed fluid per hour from the breath of a person exhaling through a glass spiral laid in ice. The fluid was always clear as water, odorless, and of neutral reaction. Nessler's reagent showed the presence of ammonia constantly, with good teeth but little, sometimes merely a trace, with bad teeth, more, though never more than 10 mg. of NH_4Cl in one litre. Traces of HCl were also constantly found. A small sediment remained on evaporation, ranging from 39 to 86.4 mg. per litre of fluid. This they believed to originate from the glass vessel; being probably calcium oxalate. They tested its reducing power upon solution of permanganate of potash, making two control determinations. The first determination showed 3.6 mg. of O for the oxidation of 1 L.; the second,

4.2 mg. of O. They were unable to obtain any alkaloid reaction in the condensed fluid, or in its distillates, by means of PtCl_4 , AuCl_3 , KClI , KBiI , KI , Bouchardet's reagent, K_2CrO_6 , picric acid, metawolframic acid, or phosphowolframic acid. Only sublimate gave at times an opalescence which, like the yellow coloration of the Nessler reagent, pointed to traces of NH_3 . Neither could they succeed, according to the method of Würtz, in obtaining a lime or oxalic acid-free filtrate. The ammoniacal silver solution, according to Brown-Séquard and d'Arsonval's method, failed to give the desired reaction—remaining clear. They confined a man, clothed in his working clothes, in a zinc cage for about one-half an hour, then allowed a boy and girl to inhale the air from the cage. No ill effects, except increase of respirations to 30 and 40 per minute, were noticeable. They had complete negative results from inoculations of condensed fluid into animals.

Lipari and Crisafulli, in 1889-90, (26), reported results which were in accord with those of Dastre and Loye, and directly opposed to those of Brown-Séquard and d'Arsonval. They could find no organic principle possessing toxic properties in the expired breath of healthy persons.

Margouty, in 1891, (27), reported the results of experiments similar to those of Hammond, and also of experiments in injecting fluid condensed from expired air into animals. His results did not correspond to those reported by Hammond, and there was no evidence of toxic properties in the injected fluids.

Haldane and Smith, in 1892, (28), published an account of experiments in which an air-tight chamber, 6 feet 2 inches high, 2 feet 11 inches wide, and 3 feet 11 inches long, was employed. Samples of air for analysis were drawn off through a tube placed in the wall of the chamber, about three feet from the floor. When one person remained in this chamber until the vitiation was from ten to twenty times as great as in the most crowded and worst ventilated public buildings, there was no perceptible odor or sense of oppression. Air vitiated to such an extent as to completely prevent a match from burning had no appreciable effect upon the subject of the experiment. In other experiments hypercæa and other phenomena produced were apparently due to the increased proportion of carbonic acid.

With rabbits weighing 1800 grammes, hæmaturia was produced when the amount of boiled distilled water injected passed beyond 100 c. c., and, therefore, 80 c. c. were taken as the maximum dose.

To obtain the condensed liquid from the lungs, a man expired through a Liebig condenser, in the jacket of which was flowing a stream of ice-cold water. The condensation liquid was collected in a flask, the bulb of which was buried in ice; and when the required amount (80 c. c.) had been obtained, it was at once injected

into the subcutaneous tissue of the back. Six rabbits were thus injected, each with 80 c. c. of the fluid, with no evident disturbance of health in any of them; 80 c. c. to a rabbit corresponds to a dose of about 3 litres to a man. They also repeated the experiments of Brown-Séquard and d'Arsonval in supplying to the animals air charged with organic matter drawn directly from the lungs of other animals. Two large rabbits were placed in an air-tight chamber and a current of air drawn through this was supplied to two young rabbits under observation; no effect was produced.

Merkel, in 1892, (29), reported an experiment in which four air-tight glass vessels, of $1\frac{1}{2}$ litres capacity, were connected by means of glass tubes; a mouse being placed in each vessel. Between the third and fourth vessels a Geissler absorption tube, containing sulphuric acid, was interposed. Air was now drawn slowly through the vessels by means of an aspirator, so that the second mouse breathed the air from the first, the third from that of the second, etc. The result was, just as in the experiment of Brown-Séquard and d'Arsonval, that the mouse in the third vessel died first, after 16-20 hours, while that in the fourth vessel remained alive.

The conclusion is drawn that, as the fourth mouse remained alive, the death of the third cannot have been due to excess of carbonic acid, or deficiency of oxygen in the air, but must have been caused by the presence of some volatile substance which is absorbed or destroyed by sulphuric acid.

The symptoms presented by the mice before death were at first restlessness and gradually increasing acceleration of respiration, afterward slowing of respiration, and finally spasmodic deep respirations, becoming constantly less frequent until the advent of death. The proportion of carbonic acid in the air led through the glass vessels was not poisonous; it amounted in the highest case to 1.5 per cent.

Merkel also conducted the expired breath through HCl with the idea of combining the organic matter with it, and believed he was successful, but the quantities of the "salts" produced were so small that determination of their chemical nature was impossible. His experiments upon animals with this body, obtained from its combination by neutralization of the acid, gave negative results.

He concludes that the expired breath of healthy persons contains a volatile poison in extremely small quantities; being probably a base which is poisonous in its gaseous state, but loses its toxicity after combination with acids. His belief in the toxicity of the organic matter contained in the expired breath of human beings is based solely upon the results he obtained in the "Brown-Séquard and d'Arsonval" experiment.

Haldane and Smith, in 1893, (30), repeated the "Brown-Séguard" experiment, using five bottles, each of a capacity of 1 to $1\frac{1}{2}$ litres, connected by means of tubes. A mouse was placed in each bottle and ventilation established through the whole system by means of a filter-pump; a small meter being placed between the last bottle and the pump. Specimens of air leaving the last bottle were drawn off at intervals for analysis. Full-grown mice were used. The mice in the last two bottles were exposed to the full effect of the vitiated air for 53 hours without detriment.

In a second experiment an absorption tube containing pumice-stone saturated with sulphuric acid was placed between the last two bottles. This experiment was continued for thirty hours; no serious effects were observed. The amount of ventilation furnished was from 12 to 24 litres per hour. The mice remained normal after having been in the bottle three days and the percentage of carbonic acid in the last bottle had varied from 2.4 to 5.2, averaging about 3.

They state that these experiments, like their former ones on rabbits and man, are distinctly against the theory that a volatile poison, other than carbonic acid, exists in the expired air.

Beu, in 1893, (31), reported the results of experiments, made under the direction of Uffelmann, in which the condensed moisture of expired air was collected by the methods usually employed, taking the precaution to cleanse his apparatus with solution of KMnO_4 and distilled water, and likewise sterilizing the apparatus before it was brought into use. The saliva is collected in a Woulff bottle attached before the condenser. The amount of air expired, measured by a gas meter, was found to be 3000 litres in eight hours, from which he collected 100 c. c. of fluid. A distinct ammonia reaction was obtained upon the addition of Nessler's reagent. Nitrate of silver failed to show the presence of chlorine.

Its reducing power upon solution of permanganate of potash showed 50 mg. of oxygen necessary to oxidize one litre of fluid, or 15 mg. in 24 hours, which denotes 0.0017 mg. per litre of expired air. The alkaloid reaction with AuCe_3 , KI, phosphomolybdate of potash, gave negative results.

He expired 500 litres through 150 c. c. of a 1 per cent. solution of HCl—then evaporating to dryness on the water-bath, a yellowish-brown deposit remained. This deposit, dissolved in distilled water, formed a fatty layer on the surface of the slightly yellow fluid. The whole quantity, 1.5 g., was warmed to the body temperature and injected under the skin of the back of a white mouse without producing observable symptoms. This fluid had a distinct odor not comparable to anything.

He next confined a mouse in a sealed glass vessel, having a globe attached

with potash solution to absorb the carbonic acid; 3200 expirations of air were conducted into the glass vessel during the three hours—no effect noticeable. In a second experiment the carbonic acid was not absorbed, the experiment lasting four hours—no effect.

He repeated the "Brown-Séquard" experiment, using white mice in four glass cages. The death of the animals, he believes, was due to changes in the temperature and the accumulation of moisture in the jars. He believes the protection afforded by H_2SO_4 in Brown-Séquard and d'Arsonval's experiments was due to its abstraction of the moisture from the air. An acute poisoning through the organic matters contained in the expired air he believes to be impossible, or at least as not shown by anything in his experiments.

Rauer, in 1893, (32), used white mice confined in glass vessels of about $1\frac{1}{2}$ litres capacity, the bottom of which was covered with oats. The cork was perforated by three tubes: one of these passed down near the bottom of the vessel and served for the entrance of the air; the second terminated just below the cork and served for the exit of air; and the third extended down to about the height of the animal but was usually closed, this was only used for the removal of air for its chemical examination. In the beginning, thermometers and hygrometers were used in the vessels, but they were found to be unimportant and were abandoned. The whole apparatus was connected with a large aspirator.

In an experiment with five animals and a ventilation of four litres per hour, the carbonic acid was found to amount to 9.3 per cent. after five hours. In another experiment with six animals and with a ventilation of $2\frac{1}{2}$ litres per hour, he inserted four absorption tubes with soda-lime between the last two jars, and a Geissler tube containing concentrated H_2SO_4 between the fourth and fifth. The sixth animal remained alive while the fifth died earlier than the fifth animal in the first experiment. He concludes that there is no organic poison in expired air, death being due to the excess of carbonic acid in the atmospheres of the jars.

Sanfelice, in 1893, (33), reported that he had repeated the "Hammond" experiment, using a flask of about 5 litres capacity, the animal dying in six or seven hours. He is undecided as to the existence of a volatile expiratory poison, though he thinks that other factors, for instance, heat radiation, have an important influence upon the results.

Lübbert and Peters, in 1894, (34), reported that they had repeated the "Brown-Séquard" experiment, placing a guinea-pig in each of a series of four flasks. Between the third and fourth flasks they placed a combustion tube through which the air coming from the third flask was conducted, passing over red-hot cupric oxide, to remove the organic matter. Before reaching the fourth flask, the air was

again cooled by conducting it through a cylinder surrounded with ice. In this manner all moisture contained in the air was condensed. From this cylinder the air passed through a series of twelve U-tubes, each made from a piece of tubing 80 cm. in length and of 2 millimeters internal diameter. During its passage through these U-tubes the air assumed a temperature of about 18° C. as it entered the fourth flask. The results obtained by this arrangement substantiated the conclusions they had formed from conducting the experiment in the ordinary manner, that the cause of death was traceable to the high per cent. of carbonic acid. The removal of the organic matter by combustion failed to save the life of the animal in the last jar when the carbonic acid had increased to 11 or 12 per cent. After the absorption of the carbonic acid by means of soda-lime the last animal remained alive. They conclude, therefore, that the poisonous expiratory poison of Brown-Séguard and d'Arsonval does not exist, but that death is produced by the excess of carbonic acid in the flasks.

Brown-Séguard and d'Arsonval, in 1894, (35), reported further experiments, and at the same time gave fuller details as to all their experiments and the apparatus employed. They had inoculated over one hundred animals with the condensed fluid of respiration and believed in the truth of their former statements as firmly as ever. They could not understand the failures on the part of the other experimenters. They emphatically reaffirm that the expired breath of man and animals contains a volatile organic poison producing the results reported by them, and that these results are not produced by excess of carbonic acid or deficiency of oxygen in the air.

From the foregoing summary of the reports of different experimenters, it will be seen that widely different results have been reported by them, but that the majority of the later investigators agree in denying that the exhaled breath of healthy human beings or of animals contains a poisonous organic alkaloid, or any poisonous product other than carbonic acid, yet in any case positive results require an explanation which shall account for the facts.

DR. BERGEY'S EXPERIMENTS.

The first experiments made by Dr. Bergey were to ascertain whether the condensed moisture of air expired by men in ordinary, quiet respiration, contains any particulate organic matters, such as micro-organisms, epithelial scales, etc. The test for micro-organisms was made by having an adult man expire for from twenty to thirty minutes through sterilized melted gelatin, which was then preserved as a culture for from twenty to thirty days. In the first trial, six, and in the second

two colonies of common air organisms developed ; but when special care was taken to thoroughly sterilize the vessels used, the result was that in two consecutive trials the gelatin remained sterile. Epithelial scales and other particulate matters were sought for by condensing the vapor of the exhaled breath and examining the product with the microscope, with and without the use of stains. In six preparations thus examined no bacteria or epithelial cells were found. This result was to be expected, since neither bacteria nor wetted particles pass into the air from the surface of fluids, or from moist surfaces, unless the air currents are sufficiently powerful to take up particles of the liquid itself in the form of spray.

Abbott (36), in his paper on "Sewer-Gas," reports some experiments made to determine the possibility of conveying micro-organisms from liquid culture media by means of a current of air bubbling through such media ; also by means of ordinary baker's yeast inoculated into media containing from 4 to 5 per cent. of glucose. No bacteria were carried from the culture by the exploding air-bubbles produced by the yeast, but a current of air equal to $3\frac{1}{2}$ litres in six hours, bubbling through a liquid culture, carried with it some of the organisms in the culture.

The determinations of ammonia in the condensed fluid of expired air, the estimation of its reducing power upon solution of permanganate of potash, and its reaction with various reagents (see Appendix, Section II.), were made with fluids collected from a healthy man, from a man with a tracheal fistula following excision of the larynx, the expired air not coming in contact with the mouth or the pharynx, and from a man suffering from well marked tuberculosis of the lungs. In each case the amount of ammonia and of albuminoid ammonia in the fluid was very small, as shown by Table B in the appendix, the average being, in grams per litre of fluid :

	Free Ammonia.	Albuminoid Ammonia.
Healthy man.....	.019	.081
Man with tracheal fistula.....	.00046.	.00036.
Consumptive.....	.003.	.0034.

The oxidizable matter in these fluids, as shown by their reducing power on a solution of permanganate of potash, was determined, and the details are given in Table C in the appendix. The average results, stated in milligrammes of oxygen consumed per litre of condensed fluid, are as follows: Healthy man, 10.72 ; man with tracheal fistula, 13.49 ; consumptive, 19.34. The high average for the man with the tracheal fistula is due to a single observation, for which the figure was 24.916. Omitting this, the average for the three other observations would be 9.68.

The average for five specimens of fluid condensed from the expired air of a healthy man four hours after he had taken a meal was 11.98, while the average for six specimens from the breath of the same man half an hour after the meal was only 3.86. For two specimens from the same man collected three and a half and four hours after a meal, but just after the mouth had been thoroughly rinsed with warm water, the average was 2.49. These results indicate that the ammonia and oxidizable organic matter in the condensed fluid were, to a large extent, due to products of decomposition of organic matters in the mouth. The well known fact that the amount of oxygen absorbed and of carbonic acid given off varies according to whether the person is fasting or has recently taken a meal, may possibly be in part due to the same cause, but the results obtained by Birkholz (37) indicate that it can only be in part. Ransome (11) reports no marked difference in the amount of ammonia, or of oxidizable organic matter, as determined by the permanganate test, contained in the fluids collected from the exhaled breath soon after a meal and in that collected from a fasting person. Beu (31) found a much higher proportion of oxidizable matter in the fluid condensed from his own breath (50 mg. of oxygen required per litre of fluid) than was found in Dr. Bergey's experiments. His results indicated the exhalation of 15 mg. of organic matter in 24 hours, the corresponding figure from Ransome's results being 20 mg. About 12 c. c. of fluid was collected from about 335 litres of air expired per hour, being nearly equal to the results obtained by Beu (31), who condensed 100 c. c. of the fluid from three cubic metres of air expired in eight hours.

Renk (38, p. 162) gives a table showing that in an average quantity of 9000 litres of air expired in a day by a healthy man, the amount of moisture may be from 200 to 400 grammes, depending on the temperature and relative moisture of the inspired air. With air containing 50 per cent. of moisture inspired at 25° C., the amount of moisture is 293 grammes, or about the result given by Beu, referred to above.

Lehmann and Jessen (25) found that between 3 and 4 mg. of oxygen were required to one litre of fluid to effect oxidation, and note that more ammonia was present in the fluid collected from a person with decayed teeth than in that obtained from a person whose teeth were sound. The very considerable differences in the amounts of ammonia and of oxidizable matter found in the fluids condensed from expired air by different experimenters, and by the same experimenter in fluids obtained from the same person at different times, are probably due to several different causes and their combinations. The amount of fluid condensed per litre of expired air varies from .003 to .004 c. c. The soundness and cleanliness of the mouth and teeth influence the amount of ammonia and oxidizable matter

expired. Variations in the amount of organic matter contained in the inhaled air may possibly influence the result, but this influence must be slight. Ransome's results indicate that the age, health, and vigor of the person may affect the amount of organic matter exhaled, and Dr. Bergey's experiments with the fluid obtained from the consumptive patient show that a smaller proportion of ammonia and a larger amount of oxidizable matter were present in it than in the fluid collected from a healthy man. It should be remembered, also, that it is extremely difficult to obtain accurate results in quantitative determinations of such very minute amounts of ammonia and oxidizable matters as are found in expired air, and a part of the differences in results obtained is no doubt due to unnoted differences in the details of the experiments.

The results of tests for the presence of an organic alkaloid in the condensed fluids obtained by Dr. Bergey were negative, corresponding to those reported by Lehmann and Jessen (25) and by Beu (31).

The results of attempts to condense the moisture of the air in the hospital ward (Appendix, III., 3) were not satisfactory, and the determinations of ammonia in the fluid obtained are not comparable, except that they show that the placing of a dust filter in front of the condensing apparatus causes a marked reduction in the proportion of ammonia in the condensed fluid. The evaporation equalled the condensation except on days when the external air was saturated with moisture, hence no moisture was collected on clear days, but on such days some dust particles may have accumulated in the apparatus which had no filter.

Some experiments were made to determine the amount of oxidizable matters in atmospheric air, the results of which are given in Table F, in the appendix. These results differ greatly, some showing a mere trace of organic matter, others showing an amount which consumed .204, .340, and .558 grammes of oxygen per 1000 cbm. of air. The great differences in the amount of ammonia in air found by different observers as tabulated by Reuk (38, p. 40), and as reported by Remsen (39), Miss Talbot (40), Nekam (41), Archarow (42), and Abbott (36), while evidently in part due to differences in methods of experiment, must be more largely due to differences in the amount of organic dusts in the air in different places or in the same place at different times, than to differences in the amount of ammoniacal gases or organic vapors in the air, and the same is true with regard to the differences in the amount of oxidizable organic matter in the air reported by Angus Smith (12), Carnelly and Mackey (43), and others.

Several series of experiments were made to determine the nature of the gaseous mixtures in which small animals die with symptoms of asphyxia. The first of these series were repetitions of the experiments reported by Hammond and described

above. Mice and sparrows were used. The details are given in the Appendix IV., 1, and the results in Table G. It was found impossible, by Hammond's method, to absorb all the carbonic acid produced by an animal, and it will be seen by Table G, that at the time of death of the sparrows, the carbonic acid had increased until it formed from 12.27 to 14.08, or an average for eight experiments of 13.24 per cent. of the air, while the oxygen had diminished to from 3.25 to 5.61, or an average of 4.67 per cent. of the air. The symptoms observed were those produced by insufficiency of oxygen, and there was no evidence that death was due to organic matters in the air. The duration of life in the animals confined was from three to six hours, being much longer than that reported by Hammond using a slightly smaller vessel, viz. less than one hour, and corresponds to the results reported by Sanfelice (33), who found that the animals lived from six to seven hours. When the experiment was so modified that all the carbonic acid was removed from the air breathed by the animal—as described in the appendix, the animal did not die in seven hours, although the percentage of oxygen had been reduced to 18.35, as shown by Table H in the appendix. These experiments, therefore, furnish no evidence of the existence of an organic poison in the expired air, but the method of absorbing carbonic acid by an alkali is said by Brown-Séguard and d'Arsonval (22) to change the organic poison which they claim to be present, and hence these experiments are not conclusive on this point.

A series of experiments was also made upon mice and sparrows to determine the time required to produce death by asphyxia when the animal is confined in a jar of known capacity, when no provision is made for removing carbonic acid and moisture, or for supplying fresh air, and also to determine the proportions of carbonic acid and of oxygen existing in the enclosed air at the time of death. In connection with these experiments it was also sought to determine the influence which high or low temperatures of the air would have on the result. The data derived from these experiments are shown in Table I in the Appendix.

A mouse weighing 21 grams, placed in a jar of 1000 c. c. capacity at a temperature of 30° C., lived four hours; in a jar of 2000 c. c. capacity a similar mouse lived seven and a half hours; in one case when the room temperature was 25.5° C., in another case when the room temperature was 5° C. In the first case death occurred when the amount of carbonic acid was 12, and that of the oxygen 8.6 per cent. of the mixture; in the second case, the proportions were 13.2 per cent. of carbonic acid and 6.4 per cent. of oxygen; and in the third case, 10 per cent. of carbonic acid and 9.2 per cent. of oxygen. There are considerable differences in susceptibility to the effects of an impure atmosphere in individual mice, but when a mouse is placed in a closed jar containing ordinary atmospheric air, the time required to

produce death is usually that required to produce the proportions of carbonic acid and of oxygen indicated above, and, hence, is in proportion to the size of the jar. A mouse should live about twice as long in a jar of 2000 c.c. as in one of 1000 c. c., other conditions as to temperature, etc., being the same, and commencing with ordinary atmospheric air.

The duration of life in the experiments with atmospheric air in closed vessels, making due allowance for variations in the air volume, coincides quite closely with the duration of life in the "Hammond" experiment. The air analyses at death of the animals in the two forms of experiment, also gave very similar results. In comparing the results shown in Tables G and I, it is necessary to bear in mind the differences in the size of the jars and in the weight of the animals used in the several experiments. As a general rule, the animal dies when the carbonic acid has increased to between 12 and 13 per cent. and the oxygen has diminished to between 5 and 6 per cent. Is death due to the increase in the carbonic acid, or to the diminution in the oxygen, or to both?

Some data for answering this question are presented in Table L, which shows the results obtained by placing animals in gaseous mixtures containing various proportions of carbonic acid, oxygen, and nitrogen. The animals experimented on were mice, rats, rabbits, guinea-pigs, and sparrows. From this table it will be seen that the diminution in oxygen in the inspired air was the most important factor in producing death, and that so long as the oxygen is present in the proportion of 6 per cent. and upwards, carbonic acid may be present to the amount of 20 per cent. without causing death. When the carbonic acid forms much more than 20 per cent. of the mixture, say 30 to 40 per cent., the oxygen must form at least 12 per cent. to preserve life.

If the proportion of oxygen in the mixture be reduced, the duration of life is shortened, as will be seen from the following extract from Table L:

No.	Weight grams.	At beginning of experiment.			At end of experiment.			Duration of life.	Capacity of jar.
		CO. %	O. %	N. %	CO. %	O. %	N. %		
8	18	0	11.35	88.65	6.56	4.14	89.3	3½ hours.	2280 c. c.
9	15	0	11.35	88.65	7.43	3.58	89.0	4½ "	2280 "
10	17	0	11.35	88.65	7.52	3.16	89.2	4½ "	2280

In these experiments the proportion of oxygen was reduced to about one-half of that in the normal atmosphere, and the duration of life was also reduced about one-

half. The jars were a little larger than those used in the experiments reported in Table I. The proportion of oxygen present at the death of the animal was between 3 and 4 per cent., or lower than in the cases reported in Table I, while the carbonic acid had increased to only about 7 per cent. instead of 12 per cent., as in Table I. The smaller proportion of carbonic acid here present seems to have allowed a greater reduction in the proportion of the oxygen. These results correspond with those obtained with mixtures of gases by Paul Bert (7, page 518), who concluded that carbonic acid when inhaled is really a poison, and with the results of the elaborate researches of Friedländer and Herter (44), which lead to the same conclusion.

In this connection the observations of Richardson (8) are of interest. His experiments were made chiefly with mice placed in jars having a capacity of 635 c. c. In such a jar containing ordinary atmospheric air at 12.8° C., a mouse weighing 18.8 grams became comatose in 1 $\frac{1}{2}$ hours, which is, he says, the average duration of life under such conditions. At a temperature of 6.6° C., the animal dies in forty minutes. In an atmosphere of pure oxygen, at 6.6° C., the animal will live only two-thirds as long as in atmospheric air, while at a temperature of 21° C. it will remain conscious for three hours and lives twelve hours, and at 10° C. it remains conscious for two hours and lives three or four hours. With atmospheric air, the modifications, he says, are less distinctly marked.

The results of similar experiments made with air, and with different mixtures of gases, at different temperatures, are given in Table J in the Appendix. These results show that the duration of life, in confined places, is influenced to a very marked degree by temperature, and that this influence is independent of the richness of the air in oxygen. Experiments Nos. 3 and 17 noted in Table J indicate that an atmosphere consisting of 90 per cent. of oxygen and 10 per cent. of nitrogen does not support life quite as long as does ordinary atmospheric air when the temperature is 0° C., while at a temperature of 50° C. the atmosphere rich in oxygen supports life much longer than the ordinary atmosphere, as is shown by experiments Nos. 5 and 15 in the table. The gradual rise in temperature which must have taken place in the experiments previously referred to, was probably but a small factor in the results obtained, because, as shown in the tables for those experiments, the duration of life and the proportion of oxygen present at death bear a constant relation to each other. This they fail to do in the "Richardson" experiments.

The toleration which is acquired by an animal by prolonged sojourn in an atmosphere which is gradually becoming richer in carbonic acid and poorer in oxygen, makes it impossible to compare the results as to duration of life in such experiments with the results of experiments in which the animal is placed at once

in an atmosphere containing abnormal proportions of these gases, so far as the effects of increase of carbonic acid and diminution of oxygen are concerned, but it is evident from the results reported in Tables I and J, that death does not occur in atmospheres in which the carbonic acid does not exceed 10 per cent. unless the oxygen is reduced to below 7 per cent. of the mixture.

A series of experiments was made by injecting into animals the fluid condensed from the air expired by healthy persons and by a man with a tracheal fistula, from whom it was possible to obtain such fluid without contamination from the exhalations from the mouth. The details of these experiments, and of the results obtained, are given in the Appendix, VI. The injections were made into the general circulation in rabbits, and into the peritoneal cavities of rabbits, guinea-pigs, and white rats, following the methods employed by Brown-Séguard and d'Arsonval (15) and by v. Hofmann-Wellenhof (23). The number of animals inoculated with the condensed fluid of respiration was thirteen, in four sets. The fluid was collected with the greatest care in a sterilized apparatus; subsequent cultures made from it indicating that it was sterile. It was warmed to about 35° C., before injection. The proportion injected, as compared with the body weight of the animals, was, in some instances, less than that used by Brown-Séguard and d'Arsonval, in others greater than the smallest quantities used by them with fatal effects. The results obtained, with the amount of fluid injected in each case, are shown in Table K, given in the Appendix.

In most of the animals no observable disturbance of health was produced, nor did this condition alter in the course of several months during which they were kept under observation. One rabbit died thirty-two days after having received an injection into its peritoneal cavity of 5 c.c. of fluid condensed from the breath of a man with tracheal fistula. The results of *post-mortem* examination showed focal necrosis in the liver, but no ecchymoses and hemorrhages in the lungs and intestines, such as are reported as characteristic result of such injections by Brown-Séguard and d'Arsonval. Three other rabbits which had received injections of the condensed fluid, and had remained apparently perfectly well from six weeks to seven months, were killed and careful *post-mortem* examinations made. The results of these examinations showed that there was no special disease or degeneration in the organs of these animals.

The results of this series of experiments are, therefore, in accord with those reported by v. Hofmann-Wellenhof (23), and indicate that fluid condensed from the pulmonary exhalations of man has no toxic or specially injurious effect when injected into animals, and that there is no evidence that such fluid contains an organic poison.

The attempt to collect condensed moisture from the air of the hospital ward was but partially successful, as has been stated above, and a sufficient amount of the fluid to make injection experiments was not directly obtained. To overcome this difficulty the air of the ward was drawn over sterilized glycerine which was then diluted with distilled water, and the product injected into animals. The results are shown in Table E in the Appendix. Three of the animals thus injected died between four and six weeks later, but the *post-mortem* examinations failed to show any clear connection between the injection and the fatal result. As it was shown that the fluid collected and the dust in the ward contained several species of bacteria, including pathogenic forms, it was to be expected that more definite results would have been obtained, but the power of the cells and tissues to resist the pathogenic organisms was sufficient to prevent their action in each case, except, perhaps, in one, in which the abscess produced may have been due to pyogenic bacteria in the injected fluid.

A number of experiments were made in which animals, in a series of bell jars, were caused to breathe air which became more contaminated with the products of respiration as it passed through the series, being a repetition of the experiments of Brown-Séguard and d'Arsonval. The form of the apparatus used, and the details as to the results obtained in each of the thirty-three experiments of this kind, are given in the Appendix, VII. These experiments were performed on sparrows, mice, guinea-pigs, and rabbits.

It was very difficult to keep the apparatus absolutely air-tight, and, no doubt, some of the discrepancies in the results, at least for the earlier experiments, are due to slight leakage of air through some one or more of the numerous joints. The more concordant results in the later experiments indicate that these defects had been obviated.

In the great majority of cases death was evidently due to the diminution in the oxygen and increase in the carbonic acid—the proportions of these gases present in the jar when an animal died being about the same as in the experiments reported in Table I, *i. e.*, the oxygen was reduced to between 4 and 6 per cent. and the carbonic acid increased to from 12 to 14 per cent. The mode of death of the animals was similar to that observed in slow asphyxia, and the results of careful *post-mortem* examination and microscopic investigation do not indicate the effects of any organic poison.

The insertion of absorption tubes containing caustic alkalies between the bell jars, to absorb the carbonic acid, as in experiments Nos. 6 to 14, and of concentrated sulphuric acid, as in experiments Nos. 15, 18, and 19, did not give results corresponding to those reported by Brown-Séguard and d'Arsonval.

In these experiments the animals were in an atmosphere of less pressure than the external air, the diminution amounting usually to about 2 mm. of mercury, but there is no reason to suppose that this exerted any influence upon the results obtained.

Experiments Nos. 17, 18, and 19 show that the mice became habituated, to a certain extent at least, to the conditions under which they were placed, and could live in an atmosphere which was almost immediately fatal to a fresh mouse placed in it. This had already been demonstrated by Bernard (5). In the case of several mice, this power to resist the foul atmosphere was preserved for from three to eight days after they had been removed from the jar, so that they had a certain degree of permanent immunity (See experiment 18, C.). Experiments Nos. 20 to 28 were made to see if it was possible to develop such an immunity, and the results obtained indicate such a possibility, but further investigation will be necessary to settle this important point. At present it is uncertain to what extent the immunity observed in a few mice was possessed by them before they were experimented on, or was produced by their first exposures to the vitiated atmospheres.

From the data accumulated with reference to the composition of the atmosphere in these bell jars by repeated analyses at short intervals, compared with the results reported by Brown-Séguard and d'Arsonval, it seems probable that the cases in which the last animal in the series survived some of the others, and a low percentage of carbonic acid was found in the jar, should be attributed entirely to defects either in methods of air analyses or in the apparatus, or in both. If, however, the life of the last animal was apparently saved by H_2SO_4 in Dr. Bergey's experiments, it was due to leakage in the connections from the increased resistance caused by the interposition of the absorption tube. This is an important fact, which is in direct opposition to the theory of Brown-Séguard and d'Arsonval with regard to the influence of the H_2SO_4 in the absorption tubes. The great differences in individual susceptibility of different animals must also be taken into account in considering the results of these experiments; for example, in experiment No. 11, sparrow No. 4 died when the percentage of oxygen was 9.34, and that of carbonic acid was only 2.79, while No. 5 lived until the percentage of oxygen was reduced to 3.53. In some mice there seems to be a very considerable immunity against the asphyxiating effect of an atmosphere poor in oxygen and rich in carbonic acid.

The duration of life of individual animals in experiments of this kind depends upon the size of the bell jars in relation to the size of the animal, on the amount of fresh air supplied, on conditions of temperature and moisture, and on individual peculiarities of the animal—and it seems probable that variations in these factors will account for the different results obtained by different experimenters. The symptoms in the animals which died were those of death by slow asphyxia.

In experiment No. 33, with a series of six rabbits confined for forty-two days, the proportion of carbonic acid in the last two jars, for the greater part of the time, was between 4 and 7 per cent. and that of oxygen between 12 and 16 per cent. None of the animals died or were seriously ill. Those in the first three and in the fifth jar gained in weight, those in the fourth and sixth lost slightly in weight.

The results of blood-corpuscle counts made for five of these animals at the close of the experiment, and again thirty-eight days afterward, show an average increase during this period of 158,600 red, and 5,400 white corpuscles per cubic millimetre, an amount which has little significance. Microcytes were found in the blood of the animals immediately after the experiment, but none were found thirty-eight days later.

The organs of a number of the animals that died in these experiments were preserved in alcohol and examined microscopically. The changes noted *post mortem* were those of profound venous congestion of all the internal organs. The lungs were frequently so charged with venous blood that the portions preserved for microscopic examination failed to float in water. The right side of the heart was usually dilated with a large firm venous clot, the left ventricle was in most instances contracted. The liver, on incision, bled freely, as did also the kidneys and spleen, the blood being quite dark and venous. All the capillaries were unusually prominent, being filled with venous blood; this was particularly noticeable in the small intestine, and in the membranes of the brain.

Microscopic examination of the organs presented a picture coinciding with the gross *post-mortem* appearances. In the lungs the capillaries were found to be distended with blood, occluding in many cases the lumen of the alveoli and air cells, and presenting a typical picture of passive hyperæmia. In the liver, kidneys, and spleen, as well as in the intestines, the capillaries were likewise overloaded with blood. Pathological changes were but rarely noted, and some of these, such as slight proliferation of connective-tissue elements between the tubules of the kidney, and, in rarer instances, in the inter-lobular spaces of the liver, are such as are occasionally found in animals which have not been subjected to such conditions, and may, therefore, have existed in the animals at the beginning of the experiment. All the changes which were constantly present may properly be attributed to the action of the carbonic acid and the low percentage of oxygen in the atmosphere, interfering with the circulation and aëration of the blood. The lesions reported by Brown-Séquard and d'Arsonval as characteristic in such cases were not seen. No focal necroses or peculiar uniform degenerative changes were found. The results of these experiments, therefore, do not agree with those reported by Brown-Séquard and d'Arsonval—and furnish no evidence of the existence of an organic poison in the air expired by animals.

CONCLUSIONS.

I. The results obtained in this research indicate that in air expired by healthy mice, sparrows, rabbits, guinea-pigs, or men, there is no peculiar organic matter which is poisonous to the animals mentioned (excluding man), or which tends to produce in these animals any special form of disease. The injurious effects of such air observed appeared to be due entirely to the diminution of oxygen, or the increase of carbonic acid, or to a combination of these two factors. They also make it very improbable that the minute quantity of organic matter contained in the air expired from human lungs has any deleterious influence upon men who inhale it in ordinary rooms, and, hence, it is probably unnecessary to take this factor into account in providing for the ventilation of such rooms.

II. In ordinary quiet respiration, no bacteria, epithelial scales, or particles of dead tissue are contained in the expired air. In the act of coughing or sneezing, such organisms or particles may probably be thrown out.

III. The minute quantity of ammonia, or of combined nitrogen, or other oxidizable matters, found in the condensed moisture of human breath appears to be largely due to products of the decomposition of organic matter which is constantly going on in the mouth and pharynx. This is shown by the effects of cleansing the mouth and teeth upon the amount of such matters in the condensed moisture of the breath, and also by the differences in this respect between the air exhaled through a tracheal fistula and that expired in the usual way.

IV. The air in an inhabited room, such as the hospital ward in which experiments were made, is contaminated from many sources besides the expired air of the occupants, and the most important of these contaminations are in the form of minute particles or dusts. The experiments on the air of the hospital ward, and with the moisture condensed therefrom, show that the greater part of the ammonia in the air was probably connected with dust particles which could be removed by a filter. They also showed that in this dust there were micro-organisms, including some of the bacteria which produce inflammation and suppuration, and it is probable that these were the only really dangerous elements in this air.

V. The experiments in which animals were compelled to breathe air vitiated by the products of either their own respiration or by those of other animals; or were injected with fluid condensed from expired air, gave results contrary to those reported by Hammond, by Brown-Séguard and d'Arsonval, and by Merkel, but corresponding to those reported by Dastre and Loye, Russo-Giliberti and Alessi, Hofmann-Wellenhof, Rauer, and other experimenters referred to in the preliminary historical sketch of this report, and make it improbable that there is

any peculiar volatile poisonous matter in the air expired by healthy men and animals, other than carbonic acid. It must be borne in mind, however, that the results of such experiments upon animals as are referred to in this report may be applicable only in part to human beings. It does not necessarily follow that a man would not be injured by continually living in an atmosphere containing 2 parts per 1000 of carbonic acid and other products of respiration, of cutaneous excretion, and of putrefactive decomposition of organic matters, because it is found that a mouse, a guinea-pig, or a rabbit, seems to suffer no ill effects from living under such conditions for several days, weeks, or months, but it does follow that the evidence which has heretofore been supposed to demonstrate the evil effects of bad ventilation upon human health should be carefully scrutinized.

VI. The effects of reduction of oxygen and increase of carbonic acid to a certain degree appear to be the same in artificial mixtures of these gases as in air in which the change of proportion of these gases has been produced by respiration.

VII. The effect of habit, which may enable an animal to live in an atmosphere in which, by gradual change, the proportion of oxygen has become so low and that of the carbonic acid so high that a similar animal brought from fresh air into it dies almost immediately, has been observed before, but we are not aware that a continuance of this immunity produced by it had been previously noted. The experiments reported in the Appendix, VII., 17 to 28, show that such an immunity may either exist normally or be produced in certain mice, but that these cases are very exceptional, and it is very desirable that a special research should be made to determine, if possible, the conditions upon which such a continuance of immunity depends.

VIII. An excessively high or low temperature has a decided effect upon the production of asphyxia by diminution of oxygen and increase of carbonic acid. At high temperatures the respiratory centres are affected, where evaporation from the skin and mucous surfaces is checked by the air being saturated with moisture; at low temperatures the consumption of oxygen increases, and the demand for it becomes more urgent.

So far as the acute effects of excessively foul air at high temperatures are concerned, such, for example, as appeared in the Black Hole at Calcutta, it is probable that they are due to substantially the same causes in man as in animals.

IX. The proportion of increase of carbonic acid and of diminution of oxygen, which has been found to exist in badly ventilated churches, schools, theatres, or barracks, is not sufficiently great to satisfactorily account for the great discomfort which such conditions produce in many persons, and there is no evidence to show that such an amount of change in the normal proportion of these gases has any

influence upon the increase of disease and death-rates which statistical evidence has shown to exist among persons living in crowded and unventilated rooms. The Report of the Commissioners appointed to inquire into the regulations affecting the sanitary conditions of the British Army (1), properly lays great stress on the fact that in civilians at soldiers' ages, in twenty-four large towns, the death-rate per 1000 was 11.9, while in the foot-guards it was 20.4, and in the infantry of the line 17.9, and showed that this difference was mainly due to diseases of the lungs occurring in soldiers in crowded and unventilated barracks. These observations have since been repeatedly confirmed by statistics derived from other armies, from prisons, and from the death-rates of persons engaged in different occupations, and, in all cases, tubercular disease of the lungs and pneumonia are the diseases which are most prevalent among persons living and working in unventilated rooms, unless such persons are of the Jewish race. But consumption and pneumonia are caused by specific bacteria, which, for the most part, gain access to the air-passages by adhering to particles of dust which are inhaled, and it is probable that the greater liability to these diseases of persons living in crowded and unventilated rooms, is, to a large extent, due to the special liability of such rooms to become infected with the germs of these diseases. It is, however, by no means demonstrated, as yet, that the only deleterious effect which the air of crowded barracks or tenement-house rooms, or of foul courts and narrow streets, exerts upon the persons who breathe it, is due to the greater number of pathogenic micro-organisms in such localities. It is quite possible that such impure atmospheres may affect the vitality and the bactericidal powers of the cells and fluids of the upper air-passages with which they come in contact, and may thus predispose to infections, the potential causes of which are almost everywhere present, and especially in the upper air-passages and in the alimentary canal of even the healthiest persons, but of this we have, as yet, no scientific evidence. It is very desirable that researches should be made on this point.

X. The discomfort produced by crowded, ill-ventilated rooms in persons not accustomed to them is not due to the excess of carbonic acid, nor to bacteria, nor, in most cases, to dusts of any kind. The two great causes of such discomfort, though not the only ones, are excessive temperature and unpleasant odors. Such rooms as those referred to are generally overheated, the bodies of the occupants, and, at night, the usual means of illumination, contributing to this result.

The cause of the unpleasant, musty odor which is perceptible to most persons on passing from the outer air into a crowded, unventilated room is unknown; it may, in part, be due to volatile products of decomposition contained in the expired air of persons having decayed teeth, foul mouths, or certain disorders of the diges-

tive apparatus, and it is due, in part, to volatile fatty acids given off with, or produced from, the excretions of the skin, and from clothing soiled with such excretions. It may produce nausea and other disagreeable sensations in specially susceptible persons, but most men soon become accustomed to it, and cease to notice it, as they will do with regard to the odor of a smoking-car, or of a soap factory, after they have been for some time in the place. The direct and indirect effects of odors of various kinds upon the comfort, and perhaps also upon the health, of men are more considerable than would be indicated by any tests now known for determining the nature and quantity of the matters which give rise to them. The remarks of Reuk (38, p. 174) upon this point merit consideration. Cases of fainting in crowded rooms usually occur in women, and are connected with defective respiratory action due to tight lacing or other causes.

Other causes of discomfort in rooms heated by furnaces or by steam are excessive dryness of the air, and the presence of small quantities of carbonic oxide, of illuminating gas, or of arsenic derived from the coal used for heating.

XI. The results of this investigation, taken in connection with the results of other recent researches summarized in this report, indicate that some of the theories upon which modern systems of ventilation are based are either without foundation or doubtful, and that the problem of securing comfort and health in inhabited rooms requires the consideration of the best methods of preventing or disposing of dusts of various kinds, of properly regulating temperature and moisture, and of preventing the entrance of poisonous gases like carbonic oxide derived from heating and lighting apparatus, rather than upon simply diluting the air to a certain standard of proportion of carbonic acid present.

It would be very unwise to conclude, from the facts given in this report, that the standards of air supply for the ventilation of inhabited rooms, which standards are now generally accepted by sanitarians as the result of the work of Pettenkofer, De Chamont, and others, are much too large under any circumstances, or that the differences in health and vigor between those who spend the greater part of their lives in the open air of the country hills, and those who live in the city slums, do not depend in any way upon the differences between the atmospheres of the two localities except as regards the number and character of micro-organisms.

BIBLIOGRAPHY.

- General report of the commission appointed for improving the sanitary condition of Barracks and Hospitals. Fol., London, 1861.
2. Leblanc (F.) Recherches sur la composition de l'air confiné. Ann. d. chim. et. phys., Par.; 1842, V, 223-268.
3. Regnault (V.) and Reisset (J.) Recherches chimiques sur la respiration des animaux des diverses classes. Ann. de chim. et phys., Par., 1849, 3. s., XXVI, 299-519, 2 pl.
4. Friedländer (C.) and Herter (E.) Ueber die Wirkung des Sauerstoffmangels auf den thierischen Organismus. Ztschr. f. physiol. Chem., Strassb., 1879, III, 19-53.
5. Bernard (C.) Leçons sur les effets de substance toxiques et médicamenteuses. 8vo, Paris, 1857.
6. Valentin (G.) Ueber Athmen im geschlossenen Raume. Ztschr. f. rat. Med., Leipz. and Heidelb., 1861, 3. s., X, 33-100.
7. Bert (P.) Leçons sur la physiologie comparée de la respiration; professées au museum d'histoire naturelle. 8vo, Paris, 1870.
8. Richardson (B. W.) On certain of the phenomena of life. Tr. M. Soc. Lond., 1861, I, 53-128.
9. Pettenkofer (M.) and Voit (C.) Untersuchungen über die Respiration. Ann. d. chem. u. pharm., Leipz. u. Heidelb., 1862-3, 2. suppl. bd., 52-70.
9. Pettenkofer (M.) Ueber die Respiration. Ann. d. chem. u. pharm., Leipz., u. Heidelb., 1862-3, 2. suppl. bd., 1-52.
9. Pettenkofer (M.) Ueber die Bestimmung des luftförmigen Wassers in Respirations-Apparate. Sitzungsab. d. bayer. Akad. d. Wissensch., München, 1862, II, 152-161.
9. Pettenkofer (M.) Ueber die Ausscheidung von Wasserstoffgas bei der Ernährung des Hundes mit Fleisch und Stärkmehl oder Zucker. Sitzungsab. d. bayer. Akad. d. Wissensch., München, 1862, II, 88-91.
10. Hammond (W. A.) A treatise on hygiene with special reference to the military service. 8vo, Philadelphia, 1863.
11. Ransome (A.) On the organic matter of human breath in health and disease. J. Anat. and Physiol., Lond., 1870, IV, 209-217, 1 tab.
12. Smith (R. A.) Air and rain: the beginnings of a chemical climatology. 8vo, London, 1872.
13. Seegen (J.) and Nowak (J.) Versuche über die Ausscheidung von gasförmigen Stickstoff aus den im Körper umgesetzten Eiweissstoffen. Arch. d. ges. Physiol., Bonn., 1879, XIX, 347-415.
14. Hermans (J. T. F.) Ueber die vermeintliche Ausathmung organischer Substanzen durch den Menschen. Ein Beitrag zur Ventilationsfrage. Arch. f. Hyg., München u. Leipz., 1883, I, 1-40.

15. Brown-Séquard and d'Arsonval. Démonstration de la puissance toxique des exhalations pulmonaires provenant de l'homme et du chien. *Compt. rend. Soc. de biol., Par., 1887, 8. s., IV, 814-818.*
16. Brown-Séquard and d'Arsonval. Resemblances entre l'action toxique de certaines ptomaines et celle du poison pulmonaire. *Compt. rend. Soc. de biol., Par., 1888, 8. s., V, 108-110.*
17. Brown-Séquard and d'Arsonval. Recherches démontrant que l'air expiré par l'homme et les mammifères, à l'éclat de santé, contient un agent toxique très puissant. *Compt. rend. Acad. d. sc., Par., 1888, CVI, 106-112.*
17. Brown-Séquard and d'Arsonval. Nouvelles recherches démontrant que les poumons sécrètent un poison extrêmement violent qui en sort avec l'air expiré. *Compt. rend. Soc. de biol., Par., 1888, 8. s., V, 33-54.*
17. Brown-Séquard and d'Arsonval. Sur quelques points importante relatifs à la durée de la survie des lapins apres l'injection sous-cutanée du liquide contenant le poison de l'air expire. *Compt. rend. Soc. de biol., Par., 1888, 8. s., V, 121-172.*
17. Brown-Séquard and d'Arsonval. Remarques sur la valeur des faits qui nous ont servi à demontrer la toxicité de l'air expiré. *Compt. rend. Soc. de biol., Par., 1888, 8. s., V, 99-104.*
17. Brown-Séquard and d'Arsonval. Nouvelles remarques à l'égard du poison pulmonaire. *Compt. rend. Soc. de biol., Par., 8. s., V, 54-56.*
18. Dastre and Loye. Recherches sur la toxicité de l'air expiré. *Compt. rend. Soc. de biol., Par., 1888, 8. s., V, 91-99.*
19. Russo-Giliberti (A.) and Alessi (G.) Sulla tossicità dell' aria aspirata. *Boll. Soc. d'ig. di Palermo, 1888, III, 331-340.*
20. Würtz (R.) Sur la présence des bases volatiles dans le sang et dans l'air expiré. *Compt. rend. Acad. d. sc., Par., 1888, CVI, 213.*
21. Brown-Séquard and d'Arsonval. Nouvelles recherches démontrant que la toxicité de l'air expiré ne dépend pas de l'acide carbonique. *Compt. rend. Acad. d. sc., Par., 1889, CVIII, 267-272.*
22. Brown-Séquard and d'Arsonval. Description d'un appareil permettant de faire respirer a plusieurs animaux de l'air libre et sur quant à ses proportions d'oxygène et d'acide carbonique, mais contenant des quantités considérables du poison de l'aire expiré. *Compt. rend. Soc. de biol., Par., 1888, 8. s., V, 110.*
23. von Hofmann-Wellenhof (G.) Enthält die Expirationsluft gesunder Menschen ein flüchtiges Gift? *Wien. klin. Wochnschr., 1888, I, 753-755.*
24. Uffelmann (J.) Luftuntersuchen, ausgeführt im hygienischen Institut der Universität Rostock. *Arch. f. Hyg., München u. Leipz, 1888, VIII, 262-350.*
25. Lehmann (K. B.) and Jessen (F.) Ueber die Giftigkeit der Expirationsluft. *Arch. f. Hyg., München u. Leipz., 1890, X, 367-381.*
26. Lipari (G.) and Crisafulli (G.) Ricerche sperementali sull' aria espirata dall' uomo allo stato normale. *Sicilia med., Palermo, 1889, I, 229.* Also, transl. [Abstr.]: *Arch. de physiol. norm. et path., Par., 1890, 5. s., II, 679.*
27. Margouty (B. M. E.) Du rôle des matières animales dans la nocivité de l'air expiré. *4to, Bordeaux, 1891.*
28. Haldane (J.) and Smith (J. L.) The physiological effects of air vitiated by respiration. *J. Path. and Bacteriol., Edinb. and Lond., 1892-3, I, 168-186.*
29. Merkel (S.) Neue untersuchungen über die Giftigkeit der Expirationsluft. *Arch. f. Hyg., München u. Leipz., 1892, XV, 1-28.*

30. Haldane (J.) and Smith (J. L.) The toxic action of expired air. *J. Path. and Bacteriol.*, Edinb. and Lond., 1892-3, I, 318-321.
31. Beu (J.) Untersuchungen über die Giftigkeit der Expirationsluft. 8vo, Rostock, 1893. Also in *Ztschr. f. Hyg.*, Leipz., 1893, XIV, 64-75.
32. Rauer. Untersuchungen über die Giftigkeit der Expirationsluft. *Ztschr. f. Hyg.*, Leipz., 1893, XV, 57-71.
33. Sanfelice (F.) Sull'aria di alcune ambienti abitati. *Ann. d. Ist. d'ig. Sper. d. R. Univ. di Roma*, 1893, u. s., III, 399-436.
34. Lübbert (A.) and Peters (R.) Ueber die Giftwirkung der Ausathmungsluft. *Pharm. Centralhalle*, Dresd., 1894, 541-548. Also, [Abstr.]: *Hyg. Rundschau*, Berl., 1894, IV, 1118.
35. Brown-Séguard and d'Arsonval. Nouvelles recherches démontrant que la toxicité de l'air expiré dépend d'une poison provenant des poumons et non de l'acide carbonique. *Arch. de phys. norm. et. path.*, Par., 1894, 5. s., XVI, 113-124.
36. Abbott (A. C.) Chemical, physical, and bacteriological studies upon air over decomposing substances, with special reference to their application to the air of sewers. *Tr. Cong. Am. Phys. and Surg.*, New Haven, 1894, III, 28-62.
37. Birkholz (W.) Ueber den Einfluss der Temperatur und der Ernährung auf ihr Kohlensäureproduktion im Thierkörper. *Inaug. diss.* 8vo, Erlangen, 1889.
38. Renk (F.) Die Luft. *Handb. d. Hyg.*, 8vo, Leipz., 1886, 1. Th. 2. Abth. 2 Hft., 1-242.
39. Remsen (I.) Report on the subject of organic matter in the air. *Bull. Nat. Bd. Health*, Wash., 1880-1, 517-521.
40. Talbot (M.) *Technol. Quarterly*, 1887, I, 29.
41. Nékám (L. A.) Ueber die Untersuchungen der organischen Substanzen der Luft. *Arch. f. Hyg.*, München u. Leipz., 1890, XI, 396-409.
42. Archarow (J.) Ueber die Bestimmung der organischen Stoffe der Luft vermittelt Kaliumpermanganat. *Arch. f. Hyg.*, München u. Leipz., 1891, XIII, 229-246.
43. Carnelly (T.) and Mackie (W.) The determination of organic matter in air. *Proc. Roy. Soc., Lond.* (1886), 1887, XLI, 238-247.
44. Friedländer (C.) and Herter (E.) Ueber die Wirkung der Kohlensäure auf den thierischen Organismus. *Ztschr. f. physiol. Chem.*, Strassb., 1878-9, II, 99-148.

APPENDIX.

DETAILS OF METHODS EMPLOYED, AND RESULTS OBTAINED, IN EXPERIMENTS UPON THE
EFFECTS OF EXPIRED AIR.

BY

DAVID HENDRICKS BERGEY, B. S., M. D.

(The numbers in parentheses refer to the bibliographical list appended to the report.)

I.—Four experiments were made to determine whether the air expired by man contains micro-organisms. The results are shown in the following table.

TABLE A.

No.	Date.	Culture medium.	Amount of medium.	Time in breathing.	Number of colonies.	Time under observation.	Remarks.
	1893 Dec. 29	Gelatin.	150 c. c.	30 min.	6	Days.	Common air organisms.
	1894 Jan. 10					30	
3	Feb. 7					30	
4	Mch. 3			20		20	

In these experiments the expired breath was conducted through melted gelatin contained in the apparatus shown in Fig. 1, for 20 to 30 minutes. The gelatin was then hardened by rolling the flask in a shallow basin containing ice-water, thus distributing the culture in a thin layer over the bottom

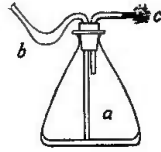

Fig. 1.—Apparatus for determining the pressure of bacteria in expired breath.

and sides of the flask. These cultures were kept under observation for 20 to 30 days. About 150 c. c. of the gelatin was used for each experiment. The glass tube, *b*, of the apparatus used, which served for the entrance of the expired air, was inserted far enough to just impinge on the fluid culture medium in the flask, so that the air produced a slight agitation of the fluid in passing through the apparatus.

Description of the apparatus used for determining the presence of bacteria in expired breath, Fig. 1.: *a*, represents a half-litre Erlenmeyer flask closed with a rubber stopper having two openings. Each of these openings is closed by a glass tube bent at right angles above the stopper.

b, represents the longer glass tube which reaches nearly to the bottom of the flask. This tube has a small bulb-shaped enlargement blown into its upper end, which serves to retain any saliva that might flow into the tube. This tube serves as the mouthpiece through which the air enters the apparatus. When not in use, the mouth-piece is closed with a small cotton plug. The internal diameter of the tube is seven mm.

c, the shorter tube is bent at right angles and terminates just below the stopper. The external end of this tube is closed with a cotton plug to prevent the entrance of micro-organisms from this side of the apparatus. The internal diameter of this tube is also seven mm.

The organisms which developed in these cultures were all of the same character—a small yellow bacillus which is quite common in the air of the laboratory. In the experiments in which gelatin remained sterile, the precaution had been taken to sterilize the apparatus with dry heat for an hour previous to introducing the gelatin, besides the subsequent sterilization of the culture medium on three successive days. If, after standing in the working room for several days, it was found that the culture medium was sterile, the expired breath was then conducted through the apparatus and the culture was kept under observation (for the time specified in the table) at the room temperature. The nature of the organisms that developed in the first two experiments, and the absence of any growth in the others, makes it probable that they developed from spores that survived the fractional sterilization of the culture medium. It is improbable that they were carried in the expired breath.

Several attempts were made to use bouillon and litmus milk instead of gelatin, as the culture medium. Neither of the former media was found to be suitable for the purpose.

Careful examination of the fluid condensed from the expired air was made with high powers, both in hanging drops, and in six dried and stained preparations, but nothing resembling bacteria or epithelium was found. A few amorphous particles, a few minute apparently crystalline masses, and here and there a fragment resembling vegetable fibre, were all that could be seen.

II.—A series of experiments was made to determine the amount of ammonia, of albuminoid ammonia, and of oxidizable matters contained in the fluids condensed from expired air.

The apparatus used in collecting the condensed vapor from expired breath is represented in Fig. 2, the condenser of which is laid in ice. Each time before this apparatus was brought into use, the condenser was boiled out with either solution of bichromate of potash and sulphuric acid, or with alkaline permanganate of potash, then freely rinsed with twice distilled water until entirely free from the cleansing solutions used. The apparatus was then quickly connected together and placed in a large steam sterilizer for an hour. The condenser was then packed in ice and the breath exhaled through the apparatus, using but little greater expiratory force than in ordinary respiration. In several of the experiments a gas meter was attached after the apparatus, in order to measure the volume of air exhaled. This was found to approximate a third of a cubic metre per hour, during which time as much as 12 c. c. of moisture was collected.

The amount of air expired in ordinary quiet respiration ranges from 400 to 500 litres per hour. It is evident that the diminished amount exhaled in the experiment did not represent the full respiratory capacity; the reduction observed having its cause, in all probability, in the slightly greater effort required to conduct the expired breath through the apparatus. It was noted that the number of expirations ranged from twelve to fifteen per minute, the ordinary rate being about

eighteen per minute. This was also caused by the slight obstruction to the respiratory current prolonging the expiratory movement. Inhalation took place through the nose.

DESCRIPTION OF FIGURE 2.

This apparatus was used to condense moisture from the expired breath. It consists of a glass mouth-piece, *a*, having an internal diameter of seven millimetres; its length being twenty centimetres. The distal end of this tube is bent at an obtuse angle and is connected with a glass tube of similar size, bent at right angles, and inserted through one of the openings of the rubber stopper of the wide-mouthed flask *b*. The other opening of this stopper carries a similar glass tube, also bent at right angles, attached to the proximal arm of the condenser *c*. To the distal arm of the condenser is attached another glass tube, also bent at right angles, passing through one of the openings of the rubber stopper of the wide-mouthed flask. The other opening in this stopper carries a glass tube of similar size, also bent at right angles, passing nearly to the bottom of the flask. The different parts of the apparatus are connected together by means of short pieces of stout, closely fitting rubber tubing. The small wide-mouthed flask *b* serves as receptacle for saliva. The tubing in the stopper closing its mouth terminates just below its inner surface. The condenser *c* is U-shaped, with each of its arms bent at right angles about half-way down in the lower dilated portion, and has an internal diameter of seven millimetres. The dilated portion of the condenser is twelve centimetres in length and four centimetres in its external diameter. The small wide-mouthed flask *e* is nearly filled with small, pea-sized pieces of pumice-stone saturated with concentrated sulphuric acid. This serves to arrest the organic matter in any air that might accidentally enter from this side of the apparatus. The U-shaped condenser rests in square glass dish *d*, 20 x 8 x 8 centimetres in its external dimensions, containing cracked ice.

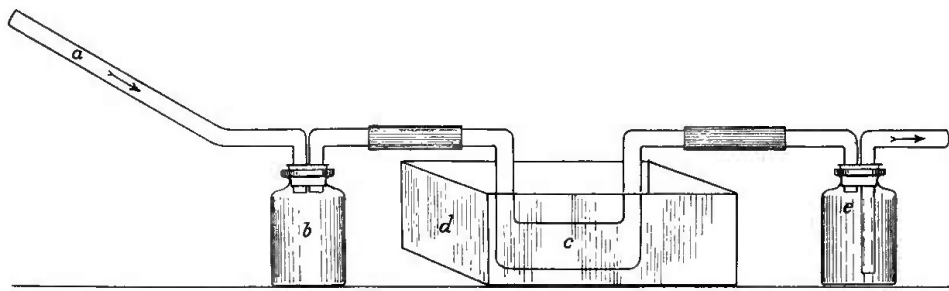

FIG. 2.—Apparatus to condense moisture from the expired breath.

In order to adapt the mouth-piece of this apparatus to the fistulous opening in the throat of the man that had had his larynx removed, the proximal end of the mouth-piece was attached to a porcelain mouth-piece used for speaking-tubes. This was padded with several layers of cheese cloth, and the loose end of this tied around his neck to hold it in position. In this manner he was able to exhale through the apparatus without any difficulty.

Some of the condensed fluid was collected from my own breath and that of other healthy persons; other portions were collected from a man having a permanent fistulous opening in his throat through which he breathed; there being no connection whatever with the mouth and upper air passages. Some fluid was also collected from the breath of a man suffering from advanced tubercular disease of the lungs.

The amount of free and albuminoid ammonia in this condensed fluid, as estimated according to the well-known method of Wanklyn, Chapman, and Smith, is shown in Table B, together with the amount of fluid used in each of these determinations and the time required to collect these portions of fluid. A definite portion of the fluid was diluted with 500 c. c. of twice distilled water,

and the ammonia in like quantity of the same water was determined simultaneously and deducted from the amount found in the diluted fluid. The minute quantities of ammonia found in the fluid in some of these determinations required the greatest care in manipulation to avoid all sources of contamination—in the collection of the fluid as well as subsequently in the distillation and nesslerization. The greatest care had to be exercised, therefore, in cleansing all apparatus used, and in the preparation of the different reagents.

The fluid for the first seven determinations was collected from my own breath, and, for the next thirteen determinations, from the breath of the man with the tracheal fistula. The remainder of the determinations were made on the fluids collected from the breath of the consumptive.

TABLE B.

DETERMINATION OF FREE AND ALBUMINOID AMMONIA IN CONDENSED FLUID OF RESPIRATION.

No.	Amount of fluid used.	Grams per litre of fluid.		Time and amt. collected.		Date.	Remarks.
		Free NH ₃ .	Alb. NH ₃ .	Minutes.	c. c. of fluid.		
	5 c. c.	.0198	.005	60	10	1893. Dec. 15	My own breath.
2	5 "	.031	.004	55	10	" 20	" " "
3	5 "	.0314	.0038			" "	" " "
4	5 "	.0026	.0162	60	12	28	" " "
5	5 "	.0028	.016			" "	" " "
6	4 "	.0245	.004	55	8.5	1894. Jan. 1	
7	4 "	.022	Defective.				
8	5 "	.0004	.0002			16	Mr. Hickey's breath. (Tracheal fistula.)
9	5 "	.0006	.0002				" " "
10	5 "	.0003	.0002			19	" " "
11	5 "	.0003	.0002				" " "
12	5 "	.0004	.0006			22	" " "
13	5 "	* Failure.	* Failure.				" " "
14	5 "	.0005	.0005			25	" " "
15	5 "	.0006	.0006				" " "
16	5 "	.0004	.0005			26	" " "
17	5 "	.0004	.0005				" " "
18	10 "	.0007	.0005			29	" " "
19	10 "	.0006	.0002			30	" " "
20	21.5 "	.0003	.0001			Feb. 1 1895.	" " "
21	15 "	.0058	.0003	65	15	Jan. 18	Consumptive person.
22	12 "	.0034	.0005	60	12.5	Feb. 7	" " "
23	15 "	.0023	.0033	120	20	" 13	" " "
24	10 "	.0005	.0095	120	16	19	" " "

The amount of organic matters present in the condensed fluid, as shown by its reducing power upon solution of permanganate of potash, is represented in Table C, the results being calculated to Mg. of O. consumed to one litre of the condensed fluid. The table also shows the amount of fluid used in each of the determinations and the time required to collect such amount. In three of the experiments the amount of air expired is also given. These determinations were made according to the methods now in common use for the determination of organic matter in water as modified by Kubel; the fluid being diluted with a definite amount of distilled water, the reducing power on permanganate of which was simultaneously determined and deduced from the results obtained. The ebullition of the fluid was always carefully timed—the time being five minutes.

* Merely a trace found.

TABLE C.

DETERMINATION OF OXIDIZABLE MATTER IN CONDENSED MOISTURE OF RESPIRATION.

No.	Date.	Time and amount collected.		Amount used c.c.	Mgm. of O. consumed to 1 litre.	Amount of air expired. Litres.	Remarks.
		Hours.	c.c. of fluid.				
	1894.						
1	Jan. 31	1	3.5	3.5	8.01		D. Hickey's breath (tracheal fistula).
2	" 31	1	4	4	11.68		" " " "
3	" 31	1	3	3	9.3458		" " " "
4	" 31	1	1.5	1.5	24.916		" " " "
5	Sept. 6	3	35	25	12.04	982.5	My own breath.
6	" 12	1	12	10	8.89	333.3	" " " "
7	" 17	35 min.	8	8	11.25	176	Dr. Gillespie's breath.
	1895.						
8	Jan. 26		7.5	7	6.86		Consumptive's
9	" 29	20	4.75	4.75	18.30		Four hours after last meal.*
10	" 29	20	4.25	4.25	2.27		Half hour " " "
11	" 30	15	4	4	Failure		Three and a half hours after last meal.
12	" 30	15	4	4	Failure.		Half hour after last meal.
13	" 31		16	16	19.32		Consumptive's breath.
14	" 31	15	3.75	3.75	10.40		Four hours after last meal.
15	" 31	15	3.75	3.75	2.60		Half hour " " "
16	Feb. 1	15	4.5	4.5	7.57		Three and a half hours after last meal.
17	" 1	10	3	3	8.10		Half hour after last meal.
18	" 2	15	3.8	3.8	10.105		Three hours " " "
19	" 2	15	3.5	3.5	15.485		Half hour
20	" 2	60	9.75	9.75	7.50		Consumptive's breath.
21	" 4	15	4	4	10.90		Four hours after last meal.
22	" 4	15	4	4	9.70		Four and a half hours after last meal, anti-septic mouth wash.
23	" 6	15	3.8	3.8	12.76		Four and a half hours after last meal.
24	" 19	120	16	5	19.12		Consumptive's breath.
25	" 28	15	3.75	3.75	Failure.		One and a half hours after meal.
26	" 28	60	6.25	6.25	33.90		Consumptive's breath.
27	" 28	10	3.25	3.25	8.83		Three and a half hours after meal.
28	" 28	10	2.75	2.75	3.47		Four hours after meal, mouth rinsed with warm water.
29	Mch. 10		2.50	2.50	7.56		Four hours after meal.
30	" 1	10	2.75	2.75	3.47		Half hour " "
31	" 2	15	3.75	3.75	2.62		Three hours "
32	" 2	15	3.25	3.25	1.515		Three and a half hours after meal, mouth rinsed with warm water.
33	" 15		4	4	1.23		Half hour after last meal.

The fluids for these determinations were collected from the breath of the man with the tracheal fistula; from the breath of the consumptive; and from my own breath and that of another healthy person. With the exception of one of the results obtained with fluid collected from the breath of the man with the tracheal fistula, which result is out of accord with the others (cause unknown), the determinations show no marked variation in the amount of oxidizable matter, whatever the source of the fluid or conditions of the person from whose breath it was collected, though only a few experiments were made. Just before collecting the fluid for several of the later deter-

* The fluids for the determinations before and after meals were collected from my own breath.

minations in the table, the mouth was well rinsed in a weak solution of formalin or with warm water. A reduction of 1.2 Mg. of O. per litre in the 23d from the amount required for the fluid collected the half an hour before, seems to have resulted from the use of the antiseptic mouth wash, in others a still greater reduction was brought about by simply rinsing the mouth several times with warm water.

Several efforts were made to obtain evidence as to the chemical nature of the condensed fluid collected from my own breath. Eighty (80) litres of expired air were conducted through 50 c. c. of a one per cent. solution of oxalic acid in ten minutes. This fluid gave a decided yellowish-brown color with 1. c. c. of Nessler's reagent, showing at least five times as much ammonia as was present in the distilled water used to make the oxalic acid solution. The fluid condensed from exhaled breath, obtained by conducting the breath through a condensing apparatus laid in ice, was tested with the following reagents for the presence of volatile organic alkaloid: AuCl_3 , PtCl_4 , Ammon. Molybdate, AgNO_3 ; reaction negative. Nessler's reagent produced a yellow color, and a few drops of a 10 per cent. solution of HgCl_2 with few drops of a 10 per cent. solution of KI also gave a yellow color.

The results of the tests, though few in number, give no evidence of the presence of expiratory products other than those indicated by the determinations of ammonia, and the reducing power on solution of permanganate of potash.

III.—Experiments with fluid condensed from the air of a large surgical ward in the University Hospital, with and without filtration of the air.

Several efforts were made to collect moisture from the air of a crowded surgical ward of the Hospital by means of a large glass funnel, sealed at the neck and filled with ice. A small beaker was placed beneath the funnel to collect any moisture condensing on its exterior. This method proved unsuccessful, and was abandoned. An apparatus, shown in Fig. 3, and arranged as shown in Fig. 4, was placed on a mantel over an unused open fire-place at one end of the ward.

Description of the apparatus used to condense the moisture in the air of the hospital ward:

Fig. 3 represents the condenser, consisting of *a*, a small glass receptacle eleven centimetres in height and three centimetres in diameter at its widest part, and having a capacity of 50 c. c. This receptacle has two openings, the one at the top being closed with a closely fitting, hollow, glass stopper; the second opening consists of a glass tube coming obliquely from the expanded portion near the top, and at a distance of three centimetres bends upward along the side of the receptacle. This serves as the exit tube to the receptacle, while the air enters through the hollow glass

stopper closing the other opening. Each of the tubes has an internal diameter of four millimetres. The spiral portion of the condenser consists of a piece of block-tin tubing, *b*, three metres in length, and five millimetres in internal diameter. This is connected with the entrance tube of the receptacle by means of a short piece of rubber tubing, and with the dust filter by a longer piece of rubber tubing. The exit tube of the receptacle has a piece of glass tubing, thirty centimetres in length, and five centimetres in internal diameter, fused to its end. This is bent at right angles near its upper extremity, and connected with the gas meter by means of a piece of rubber tubing.

Fig. 4, represents the apparatus as arranged in the hospital ward. *a* represents an inverted bell-jar with the condenser packed in ice. The bell-jar is supported by an iron tripod, *b*. The dust filter, consisting of glass tube loosely packed with asbestos, is represented at *c*, and is attached to a stove by means of a clamp, while *e* represents the gas meter, and *f* the water faucet in the lavatory. The meter is connected with the faucet by means of a long piece of block-

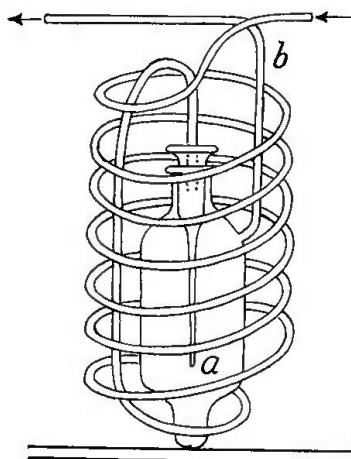

FIG. 3.—Condenser of apparatus shown in Fig. 4. (X 5.)

tin tubing of $1\frac{1}{4}$ centimetres internal diameter. *g* represents the Chapman water pump attached to the faucet.

The dust filter, *c*, is twenty centimetres in length, consisting of a narrow portion four centimetres long and three millimetres in internal diameter, and of a wider portion sixteen centimetres long and twelve millimetres in internal diameter.

The condenser was cleansed by rinsing it with a solution of bichromate of potash and sulphuric acid, then removing all trace of this solution by rinsing it repeatedly with twice distilled water. The cleansing of the apparatus was greatly facilitated by attaching it to a Chapman water pump in the laboratory, and drawing the cleansing solution and distilled water through it in large quantities. It was then placed in the inverted bell jar, packed in ice, and connected with the meter and pump in the hospital ward.

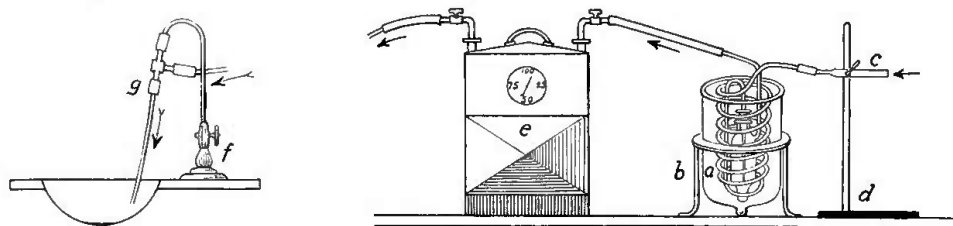

FIG. 4.—Apparatus used to condense moisture from the air of the Hospital Ward.

With this apparatus a small amount of fluid was collected on days when the atmosphere was saturated with moisture, but if this fluid was allowed to remain in the receptacle during several days of clear weather it slowly evaporated. However, enough fluid was collected in this manner to make several determinations of the free and albuminoid ammonia in it. The results thus obtained are shown in Table D; the first and third experiments showing results obtained without placing a dust filter of asbestos before the condenser. The second and fourth experiments show the results obtained by attaching such a dust filter.

TABLE D.

DETERMINATION OF FREE AND ALBUMINOID AMMONIA IN THE MOISTURE CONDENSED FROM THE AIR OF THE HOSPITAL WARD.

No.	Date.	Time.	Litres of air aspirated.	Amt. of moisture condensed.	Grms. per 1000 cbm. air.		No. of bacteria per c. c. of fluid.	Remarks.
					Free NH ₃ .	Alb. NH ₃ .		
	1894 Dec. 13	Hours. 43½	4612.9	3. c. c.	0.0210	0.0028	3140	No dust filter.
2	1895 Jan. 9	41½	3990.3	7.	0.00075	0.00125	1331	Dust filter.
3	" 18	34¼	1669.7	3.	0.0012	0.0015		No dust filter.
4	Mch. 4	33	1980.0	2.6	0.0015	0.0010		Dust filter.

Microscopic examination of the fluid condensed from the air of the hospital ward showed: a number of small amorphous particles—black, yellow, and colorless; a few small crystals, a few epithelial scales, small bits of vegetable fibre, and a few bacteria.

Cultures made from this fluid showed numerous colonies of moulds, numerous common air and water organisms, some of which rapidly liquefied the gelatin of the cultures. *B. pyocyaneus* was found in one instance, in others a yellow *sarcina*, and yeasts of different colors. Besides these a

bacillus belonging, apparently, to the *B. coli* group was found in most of the cultures; in one instance this bacillus was present in very large numbers and excluded nearly all the other forms. It was also noted in the gelatin plates exposed in the ward, and in the cultures from dust collected near the apparatus.

On several occasions the dust which had collected on the meter and mantel during the night was taken up on a sterilized cotton swab and inoculated upon gelatin plates. The cultures in these plates did not differ greatly from those made from the fluid, except that the moulds were present in larger proportion than the other organisms noted in the cultures from the fluid.

Gelatin plates exposed to the air of the ward showed the same character of organisms as in the cultures from the condensed fluid and those which developed from the dust collected in the vicinity of the apparatus. In addition to the species already noted, colonies of *staphylococcus aureus* and *albus* were also noted in these plates.

The small amount of fluid collected from the air of the hospital ward in the manner stated, and the rapidity with which it evaporated on clear days, made it impossible to collect a sufficient quantity to inoculate it into animals. To overcome this difficulty a small quantity of sterilized glycerine (7.5 to 10 c. c.) was aspirated through the condensers after it had been cleansed. It is doubtful, however, whether this served to withdraw an appreciable amount of moisture from the air. After aspirating air through the apparatus for several days it was brought to the laboratory and the fluid in the receptacle transferred to a small sterilized flask. The condenser was then washed out by aspirating 8 to 10 c. c. of twice distilled water (sterilized) through it. This was added to the fluid poured from the receptacle, thoroughly mixed with it, and inoculated into animals. The glycerine in this fluid inoculated into the animals was diluted at least 50 per cent. Three sets of animals were inoculated and each time a control animal was inoculated with equal parts of glycerine and distilled water that had been sterilized for one hour. The results of these experiments are shown in Table E.

TABLE E.

COLLECTION OF BACTERIA, ETC., FROM THE ATMOSPHERE OF THE HOSPITAL WARD, USING GLYCERINE IN THE ABSORPTION APPARATUS.

No.	Date	Time.	Litres of air Aspirated.	Amt. of glycerine used.	Weight of rabbit and amt. of fluid injected.						No. of bacteria in dilute fluid, per c. c.
					Weight.	c. c.	Weight.	c. c.	Weight. (control animal.)	c. c.	
		Hours.			Grams.		Grams.		Grams.		
1	1894. Dec. 5	47½	13338.8	10 c. c.							900
2	" 11	69½		10 "							450
3	1895. Jan. 1	47½	7754.2	7.5 "	3050	6	1130	2	1025	2	2675
4	" 3	44½	7669.3	7.5 "	2205	6	2350	6	2205	6	1893
5	" 5	52½	4924.2	7.5 "	1970	6	1280	6	1400	6	1646

The animals inoculated with the products collected from the air of the hospital ward in the manner stated were under observation for two months. Three of these animals died during the time they were under observation. The control animal of the third series died after twelve days. This animal was observed to be in poor health for several days before its death. On examination, *post mortem*, it was found to have had a good-sized abscess in the right axillary fossa, which had ruptured externally: The liver presented numerous whitish bands and foci on all of its surfaces and throughout the matrix. A number of echinococcus cysts were found adherent to the liver, spleen, and the omentum. The kidneys were normal in size and appearance, and the capsule was easily removed. The other organs appeared normal.

Cultures were taken from the abscess, blood, lungs, liver, spleen, and kidneys. Those from the site of the abscess were the only ones developing any growth. The prevailing organisms in the cultures from the abscess were *staphylococcus albus* and *aureus*.

Cover-slip preparations were made from the abscess, blood, lungs, liver, spleen, and kidney. Those from the site of the abscess were the only ones showing any organisms; numerous cocci, with a few bacilli, were observed.

Microscopic examination of the organs hardened in alcohol and mounted in celloidin: The liver presented some increase of connective-tissue elements between the lobules. The whitish bands on the surface of the organ, noted at the autopsy, were found to be due to this increase in connective-tissue elements in the inter-lobular spaces. No change was noticed in the liver cells themselves. All the other organs were found to be normal.

The nature of the substances inoculated into this control animal (6 c. c. of equal parts of sterilized glycerine and distilled water) and the antiseptic precautions observed in the inoculation make it doubtful whether the source of infection is traceable to the experiment. The changes noted in the liver are of such a nature as to indicate their production by causes preceding even those which brought about the death of the animal.

Rabbit No. 2 of the first series, having received 2 c. c. of the fluid obtained by aspirating the air of the hospital ward through the condensing apparatus moistened with sterilized glycerine, died after 35 days. Autopsy: Half-grown rabbit, poorly nourished, and adipose all used up, presented nothing important externally. Internally: A small amount of clear fluid in the abdominal cavity; the liver is somewhat darker than normal, mottled, and contains a few psorosperms. Spleen is normal. Kidneys and adrenals are normal in appearance. The right lung is considerably congested, being readily torn; the left is also slightly congested. The right side of the heart is filled with dark fluid blood; the left side is nearly empty. Several echinococcus cysts were found in the abdominal cavity.

Cover-slip preparations were made from the abdominal fluid, the kidneys, liver, spleen, lung, and blood; all proved negative.

The organs were preserved in alcohol and mounted in celloidin for microscopic examination.

Microscopic examination of the organs: Left lung showed the capillaries and larger vessels very much dilated and filled with blood. Infiltration of leucocytes was noted here and there. Right lung showed marked proliferation of cells and infiltration of leucocytes. Many of the air cells were obliterated. The liver, kidneys, and spleen were normal.

Rabbit No. 1 of the second series, inoculated with the fluid obtained from the air of the hospital ward, died after 38 days. Autopsy: Full-grown rabbit, shows numerous bruises and lacerations of the skin over various parts of the body. Many of the wounds along the sides and back show ecchymoses under the skin. Adipose not all used up. Internally: Liver slightly darker and somewhat larger, apparently, than normal. Spleen is larger than normal. Kidneys embedded in fat, normal in appearance. Lungs and heart normal. Blood is dark and fluid.

Cover-slips were made from all the organs with negative results.

The organs were preserved in alcohol and mounted in celloidin for microscopic examination.

Microscopic examination of the organs: No abnormalities could be found in any of the organs; all appearing to be normal.

The remaining rabbits of these series showed no symptoms of any deleterious influence from the fluid inoculated. No swelling or formation of abscess was noted in any of them.

Rabbit No. 2 of the first series evidently died of lung disease, as shown at *post mortem*. As to the causation of this disease, it is impossible to venture an opinion. Rabbit No. 1 of the second series died of causes which left apparently no manifestations pointing to their nature.* Rabbit No. 3 (control) of the third series evidently died from the effects of the extensive axillary abscess. As to the source of the infection, no decided opinion can be given. Probably the infection gained an entrance through the inoculation wound.

Some experiments were made to determine the amount of oxidizable matter in atmospheric air. At first a measured amount of air was slowly aspirated through twice distilled water, and the amount of oxidizable matter extracted from the air estimated according to the method used for determin-

*Death may have resulted from injury, as shown by the contusions and wounds noted at autopsy. These wounds were probably inflicted by other rabbits in the same cage.

ing the oxidizable matters in the condensed fluid of respiration. In the later experiments the air was conducted through two flasks—the first containing 100 c. c. of a 1 per cent. solution of sulphuric acid, the second 100 c. c. of a per cent. solution of potassium hydroxide. After aspirating a measured amount of air through these solutions, 50 c. c. of each were mixed together and the amount of oxidizable matter determined as in the earlier experiments. The results are shown in Table F.

TABLE F.
DETERMINATIONS OF OXIDIZABLE ORGANIC MATTERS IN ATMOSPHERIC AIR.

No.	Absorbent used.	Amount used c. c.	Litres of air aspirated.	Time of aspiration.	O. consumed to 1000 b. m. of air.	Date.	Remarks.
				Hours.	Grms.	1894	
	Distilled H ₂ O.	125	200	20	.340	Aug. 20	Laboratory air.
2	"	150	240	22	*Failure	" 21	" "
3	"	150	240	20	.121	22	
4	"	150	240	20	.058	23	
5	"	150	240	20	Failure	24	
6	"	150	240	20	Failure	25	
7	"	150	240	20	Failure	26	
8	"	150	300	20	.030	27	
9	"	150	320	20	.059	29	
10	"	150	280	20	.085	30	
11	"	150	369	20½	.013	Sept. 6	
12	"	100	900	50	.204	" 8	
13	"	150	360	24	Failure	11	
14	"	150	360	20	Failure	12	
15	{ 1% solution H ₂ SO ₄ 1% " K H O	100	1000	22	.558	18	External
16	"	100	911.25	20	.086	Oct. 2	
17	"	100	690.5	20	.068	3	
18	"	100	433	20	.062	4	
19	"	100	447	22	.007	6	

These experiments were made at a season of the year when the windows of the laboratory were open most of the time and the amount of dust floating in the laboratory air must have been about equal to that in the external air. The method employed to obtain the oxidizable matter from the external air is preferable to that employed for the laboratory air, and, since equal portions of the solutions used neutralize each other, they have no objectionable influence upon the process of determination of the oxidizable matter.

In several instances a portion of the water, containing the oxidizable matter extracted from the air, was treated with AgNO₃, HgCl₂, AuCl₃, PtCl₄, K₄FeCy₆, K₆Fe₂Cy₁₂, KHO, Ba(HO)₂, H₂SO₄, I, and with phosphomolybdic acid, am. molybdate, but no reaction was obtained with any of these, either in hot or cold solution. Nessler's reagent gave a deep yellow color, and HgCl₂ with KI produced a lemon-colored precipitate, rapidly changing to red, with deposit of HgI₂.

IV.—Experiments on mice and birds confined in glass jars, by the method used by Hammond (10).

The exact conditions under which Hammond conducted his experiment are not given in his treatise, and the size of the jar he used is uncertain. Taking the relative sizes of the animal, jar, and the other parts of the apparatus shown in the accompanying figure, it seems probable that he used a jar of at least four litres' capacity. In the apparatus used for our experiments, two- and four-

*By "Failure" is meant that merely a trace of organic matter was found.

litre jars were used. The arrangements for the absorption of moisture, CO₂, and for the introduction of fresh air, were the exact counterparts of these arrangements in Hammond's apparatus, judging from his description and engraving. Fresh air was supplied at intervals of one-half to one hour. This was accomplished by attaching a graduated aspirator to the Geissler potash bulbs containing the Ba(OH)₂ solution.

The results obtained in these experiments are shown in Table G. Hammond claims that in his experiments a mouse invariably died within one hour. In our experiments all the animals lived over three hours, and some even longer than six hours. The great difference in the duration of life for different animals may be accounted for in the varying susceptibility of different animals of the same species to the atmospheric conditions in the jar, but the still greater difference in the duration of life in our experiments, as compared with Hammond's results, cannot be attributed to the same cause, and, since it is not known positively what the capacity of the jars was which he used it would be useless to speculate on the point.

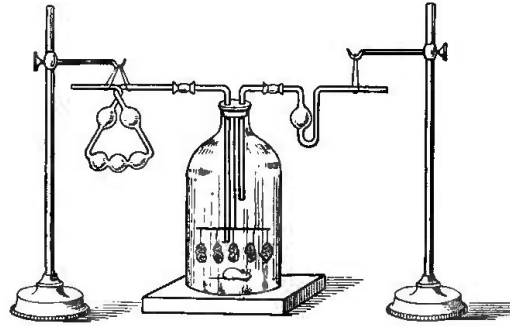

FIG. 5.—Hammond's apparatus.

Fig. 5 shows Hammond's apparatus as given in his treatise (Fig. 10, p. 170), and is an accurate representation of the apparatus used by us, except that it does not show the graduated aspirator connected with the free end of the Geissler potash bulbs, by means of which a known amount of fresh air was introduced at stated intervals during the experiment.

TABLE G.
THE "HAMMOND EXPERIMENT."

No.	Date.	Capacity of the jar.	Amt. of air aspirated.	Time.	Animal.	Weight.	Exam. of air.		Remarks.
							CO ₂ .	O.	
	1893.			H'rs.		Grms.	%	%	
	Dec. 15	4000 c. c.	250 c. c.	5	Sparrow.	20			Alive; revived.
	" 16	" "	185 "	5½	"	20			" "
3	" 18		600	6	Mouse.	14			"
4	" 19		600	6	"	15			
5	" 20	2000	300	6		14			
6	" 20	"	300	6		15			
7	" 21	4000	225	5	Sparrow.	26			} Same animal.
8	" 22	"	225	5	"	26			
	1894.								
9	Feb. 9		300	3					Died.
10	" 9		350	4					"
11	" 10		400	3¼					
12	" 10		400	3¼					
13	" 12		500	5½					
14	" 12	"	350	3½					
15	Mch. 6	"	550	6½		23	13.80	5.61	
16	" 6	"	550	4¾		23	13.75	5.60	
17	" 7	"	250	5½		21	13.04	4.75	
18	" 7	"	250	5½		21	12.50	4.875	
19	" 9	"	250	4¾		25	12.79	5.59	
20	" 9	"	350	6¾		21	12.27	3.94	
21	" 10	"	200	4¾		25	14.08	3.74	
22	" 10	"	200	4½		22	13.69	3.25	

The determinations of the proportions of CO_2 and of O in the air of the jar at the end of the experiments were made with the Bunte gas burette represented in Fig. 6. For rapid determinations this apparatus gives quite satisfactory results, and one soon learns to manage it easily and obtain results concordant with those obtained by other methods. It is not claimed that the results so obtained are absolutely accurate, but any error resulting from the use of this burette is a constant one in all the air analyses for the different experiments reported on, and is without influence on the results obtained.

a represents the burette proper; the upper portion is of larger size than the lower, which is marked with a scale extending from zero near the bottom to 100 c. c. just below the expanded portion above, and from the zero mark down to 10 c. c. near the lower extremity of the tube. The capacity from the 100 c. c. mark to the three-way stop-cock, *b*, closing its upper end, is 50 c. c.—making the entire capacity of the tube 160 c. c. The lower end is closed by means of a simple glass stopcock, *c*. *e* represents a small cup at the top with marks at 20 and 25 c. c. respectively, thus facilitating the measurement of the contained volume of gas at a constant pressure of known amount of water in the cup.

f represents an iron stand to which the burette is firmly clamped.

d represents a glass tube of wider calibre surrounding the burette, filled with water and serving as a water-jacket to prevent rapid changes in temperature of the gases under examination.

METHOD OF USING BUNTE'S GAS BURETTE.

The burette is filled with water and the three-way stopcock closing its upper end is so turned as to communicate through it with the external air, or with the vessel containing the air to be analyzed, by means of a short piece of rubber tubing connecting this stopcock with such vessel. By opening the stopcock, closing its lower end, some of the water, say 150 c. c., is allowed to flow out, and the air or gas to be analyzed flows in to take its place. When the desired amount of the sample of air has been taken, the lower stopcock is quickly closed and the three-way stopcock is turned half-way round, thus bringing it in communication with the small cup at the top, which should also be filled with water to its 25 c. c. mark. The pressure of the contained air is now equalized and the communication with the cup is closed. A few drops of water always lodge just below the upper stopcock; these must be dislodged by gently tapping the iron stand on the floor. In a few minutes the volume of air may be read off. The burette is then connected at its lower end with a Chapman water pump and a portion of the water in it is drawn off. The water in the cup is then poured out and about 10 c. c. of a 40 per cent. solution of sodium or potassium hydroxide poured into it, and in turning the stopcock, this flows in to take the place of the water just removed. The fluid and air in the burette are now

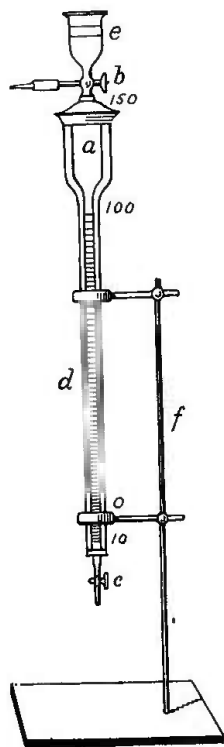

FIG. 6.—Bunte's Gas Burette ($\times 1\frac{1}{2}$).

gently agitated, at intervals, for five minutes, the cup is again filled with water to the 25 c. c. mark, the stop-cock again opened, and the pressure of the gas equalized. If any of the water flows into the burette more must be poured into the cup to retain the gas under the original pressure of 25 c. c. of water in the cup. This part of the operation requires some care and practice in order to prevent the escape of any of the contents of the burette or the entrance of external air. When the pressure is again equalized the volume of gas is again read off, the reduction in volume representing the amount of CO_2 absorbed, this is readily calculated to the per cent. of the original volume of gas.

The burette is now once more attached to the Chapman water pump to remove a portion of the fluid in the burette. About 10 c. c. of a 12 per cent. solution of pyrogallic acid is poured into the cup and allowed to flow in. The fluid and gas are gently agitated, at intervals, during five minutes, the pressure equalized as before, the volume of gas read off, and the calculations for O made as before. In most instances N is the only gas remaining.

From the determinations of the proportions of CO_2 and of O. in the air of the jar, after death of the animal, in the Hammond experiments, it is evident that two factors were operative in killing it. These were the low percentage of O. present and the high percentage of CO_2 , which the arrangements instituted for the absorption of this gas had failed to remove. In a short time the exterior of the sponges became coated with BaCO_3 while the $\text{Ba}(\text{HO})_2$ in the interior became inoperative. This can be demonstrated by determining the alkalinity of the fluid expressed from the sponges, at the end of the experiment, with solution of oxalic acid. Another fact which substantiates such a conclusion is that of the clouding of the $\text{Ba}(\text{HO})_2$ in the Geissler potash bulbs quite early in the experiment from the CO_2 in the air aspirated from the jar in supplying fresh air. While the solution of $\text{Ba}(\text{HO})_2$ used in the sponges was twice the strength of that usually employed in CO_2 determinations in the Pettenkofer flask method, the amount of solution which can be taken up by the sponges of the size used (about 10 c. c. each) is entirely too small to absorb more than a fractional part of the CO_2 generated by an animal during the time of an experiment.

The mode of death in these experiments presented such a close similarity to that noted in cases of CO_2 poisoning, under other circumstances, that it was impossible to distinguish it from death produced by that gas. Judging from the air analyses at death of the animals, from the constancy of the symptoms and the close similarity of the gaseous contents of the jars at death of the animals, and, besides these, the absence of any positive indications of the presence and action of other poisonous expiratory products as manifested either by the action of the animals or the mode in which death took place, it is safe to conclude that the low percentage of O, together with the high percentage of CO_2 , in the atmosphere of the jars, were the principal causes of death. The mode of death differed in no particular from that noted in the case of animals dying in the closed vessels, in the "Brown-Séguard" experiments, or in those made with artificial gaseous mixtures where sufficient oxygen was present to support life for several hours. Another fact, observed likewise in all the other forms of experiment reported on, was the prompt revival of the animals when removed from the jars and supplied with fresh air. In exceptional cases, where the animal was not removed until death was certain to take place in a very short time, the revival of the animal did not follow on removal from the jar, but death supervened at a shorter or longer period after removal. The failure of these animals to revive might be attributed to the presence of *ante-mortem* clots within the heart cavities produced by the long-continued respiration of such high percentages of CO_2 as existed in the atmosphere of the jars in this and the other experiments. The prompt revival of the animals removed from the jars a little earlier appears to be an additional indication that the symptoms produced in these experiments had been due to the relative proportions of O and CO_2 present in the atmosphere which the animals breathed. The effects of an organic volatile poison would not allow such rapid recovery, and would most probably manifest itself by continued ill-health on the part of the animals subjected to it.

Some animals vitiated the contained air more rapidly than others, so that, while there is a close relation between the composition of the atmosphere at the end of the experiments, it is evident that the degree of respiratory interchange determined the duration of life for each individual. The room temperature for these experiments was very nearly constant— 18° to 25° C.

A further attempt was made by modifying the apparatus. This modification is shown in Fig. 7. Here the CO_2 is absorbed by passing the air, issuing from the bell-jar containing the animal, through five Pettenkofer absorption tubes, each containing 100 c. c. of a strong solution of $\text{Ba}(\text{HO})_2$ [10 g. $\text{Ba}(\text{HO})_2 + 8\text{H}_2\text{O}$ to r L.]. In addition to this, the air is passed through two Pettenkofer tubes, each containing 100 c. c. of Buchner's alkaline pyrogallate solution, to remove some of the O from the air. The moisture is absorbed by CaCl_2 placed in a shallow vessel, covered with a perforated porcelain plate, in the bottom of the bell-jar.

DESCRIPTION OF THE APPARATUS USED IN THE MODIFIED "HAMMOND" EXPERIMENT, FIG. 7.

a represents a one-litre bell-jar resting on a ground-glass plate, and contains a shallow vessel with CaCl_2 . The vessel containing the CaCl_2 is covered with a perforated porcelain plate on which the mouse under experiment is placed.

b b are the two aspirating flasks, of four litres' capacity, partially filled with saturated salt solution. By reversing their positions these aspirators give a continuous current of air. The rubber cork closing the top of these flasks carries two glass tubes with glass stopcocks, and the apparatus is so constructed as to maintain the air current in the same direction by closing one, and opening the other, of these glass stopcocks when the flasks are reversed in their positions.

The Pettenkofer tubes containing the $\text{Ba}(\text{HO})_2$ are attached to the stative *c*, and those containing the pyrogallate solution to the stative *d*.

e represents a stopcock in the tubing connecting the aspirators. This serves to control or arrest the aspiration.

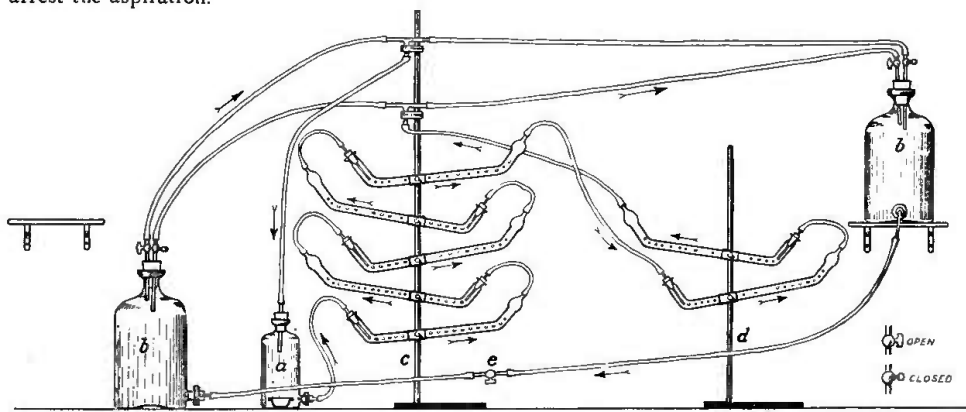

FIG. 7.—Modified Hammond Apparatus (devised by Abbott).

The results obtained with this modification of the apparatus are shown in Table H. The same animal was used in each of the six different experiments performed, and it failed to succumb to the conditions present in any of them. In the later experiments, in which the animal was placed in a one-litre bell-jar, it failed to reduce the proportion of O in the volume of air within the apparatus (about six litres) to such an extent as to endanger its life, even with the additional reduction of O taking place in the two Pettenkofer tubes containing Buchner's solution of alkaline pyrogallate. The percentage of CO_2 remained quite low through the absorption by the $\text{Ba}(\text{HO})_2$ in the five Pettenkofer tubes. The construction of the apparatus permitted the continuous circulation of the air within the apparatus so that the animal was constantly breathing air that had been breathed and

TABLE H.
MODIFIED "HAMMOND" EXPERIMENT.

No.	Date.	Animal.	Weight.	Aspiration.	Number of absorbers.	Capacity of jar.	Time.	Examination of air.		Remarks.
								CO_2 .	O.	
	1894		Grams.				Hours.	%	%	
	Oct. 24	White mouse.	23	Continuous.	5 $\text{Ba}(\text{HO})_2$ tubes.	4000 c. c.	$7\frac{1}{4}$			Mouse quite sick.
2	25	"		"	"	"	$8\frac{1}{2}$			
3	26	"		"	"	1000 c. c.	6			
4	27	"		"	{ 5 $\text{Ba}(\text{HO})_2$ 2 Pyro.	"	$4\frac{3}{4}$.33	9.44	Previous aspiration 2 hours.
5	31	"		"	"	"	7	—	18.35	Previous aspiration 12 hours.
6	Nov. 3	"		"	"	"	$6\frac{1}{4}$			Previous aspiration 10 hours.

rebreathed before. The direction of the air current through the apparatus is shown by the position of the arrows in the figure. By changing the position of the aspirating flasks, and turning the stop-cocks in the glass tubing inserted through the stoppers closing the upper openings of the aspirators, the current was maintained in the same direction as before, and the entrance of external air was thereby prevented.

The results obtained show that, with the absorption of the CO_2 as generated, the mouse remained relatively comfortable in the atmosphere present and that no deleterious effects developed from the continued rebreathing of the air confined within the apparatus. The animal seemed to be somewhat oppressed toward the close of each experiment, but revived quickly after removal from the apparatus.

The air contained in the two aspirating flasks was retained each time in the later experiments. Consequently in these experiments the fresh air-supply comprised only that which was enclosed in the Pettenkofer tubes, the rubber connecting tubes, and in the bell-jar containing the animal. In several of the later experiments the volume of air within the apparatus was aspirated continuously through all its parts for some hours before beginning the experiment. In this manner the pure air-supply was reduced to one litre, the amount of air in the bell-jar containing the animal.

V.—Experiments to determine the proportions of CO_2 and of O in the air of a glass vessel in which small animals (mice and birds) had remained until death was produced, and the effects of different temperatures upon the duration of life and on the composition of the residual atmosphere after death in such cases.

The results obtained in these experiments are shown in Table I. At the room temperature death did not take place until the amount of oxygen present was too low to support life. At a higher or lower temperature there was a slightly shorter duration of life, varying with the amount of increase or reduction of the temperature.

TABLE I.
EXPERIMENTS WITH ANIMALS IN CLOSED VESSELS—ATMOSPHERIC AIR.

No.	Date.	Capacity of the jar.	Temperature.	Time.	Animal.	Weight.	Exam. of air.		Remarks.
							CO_2 .	O.	
	1893			Hours.		Grams.	%	%	
1	Nov. 27	1000 c. c.	29.5° C.	4	Mouse.	18 $\frac{1}{2}$	13.818		
2	" 28	" "	25.° C.	3 $\frac{5}{8}$	"	18 $\frac{3}{4}$	17.66		
3	Dec. 5	2000	23.5° C.	5		22 $\frac{3}{4}$			
4	" 6	" "	23.5° C.	7 $\frac{1}{2}$		15 $\frac{5}{8}$	17.30		
5	" 14	" "	" "	8 $\frac{1}{2}$		11 $\frac{5}{8}$	13.12		
6	1894	1000	29.° C.	3 $\frac{1}{8}$		19 $\frac{1}{2}$			
7	Jan. 26	" "	30.° C.	4		21	12.00	8.60	
8	" 27	" "	30.5° C.	4 $\frac{1}{8}$		11	12.00	8.60	
9	" 30	2000	31.° C.	4		21			
10	Feb. 1	" "	31.° C.	4 $\frac{1}{8}$					
11	" 2	" "	7.5° C.	7			12.60	8.00	
12		" "	5.° C.	7 $\frac{1}{2}$			10.00	9.20	
13		" "	25.5° C.	7 $\frac{1}{2}$			13.20	6.40	
14		" "	24.° C.				11.90	7.50	Cold-water cloths applied to the outside of the jar at temperature of 11° C.
15	9			2	Sparrow.				
16	9			2 $\frac{1}{10}$	"				
17	13		27.5° C.	2 $\frac{1}{4}$			12.75	5.86	
18	13		27.5° C.	2 $\frac{1}{4}$					
19	Mch. 28	7000 c. c.	30.° C.	9		24	13.28	4.89	
20	" 29	" "	29.5° C.	7 $\frac{3}{4}$		23	13.485	7.37	
21	" 30	" "	11.5° C.	9 $\frac{3}{4}$		23	13.00	6.929	
22	" 31	" "	12.° C.	8 $\frac{1}{8}$		22	87.97	5.534	

THE COMPOSITION OF EXPIRED AIR.

The effects of temperature upon the duration of life in a confined space (and even in the open air) are better shown in the repetition of Richardson's experiments (8), as presented in Table J. The results obtained in these experiments show that the duration of life is very perceptibly shortened through the influence of a higher as well as of a lower temperature than 18° to 20°C.

TABLE J.
"RICHARDSON'S" EXPERIMENT.

No.	Date.	Animal.	Weight.	Capacity of jar.	Temperature.	Atmosphere.	Time.	Exam. of air.		Remarks.
								CO ₂	O.	
1	1894. Nov. 5	White mouse	22	600	48° C.	Air.	5 min.	1.90	18.25	Died.
	5	"	22		8.5°		2½ hrs.	12.7	3.7	
3	5	"	21½		0.0°		1 "	11.4	6.05	
4	5	"	20½		16.2°		3	13.15	2.6	
5	6		16		50.°		16 min			Flask plunged in hot water—open at top. Same as in No. 4. Remained alive.
6	6	Gray mouse	20	1000	42.°		30 "			Same as in Nos. 4 and 5. Died.
7	6	"	12		58.°		21			Rapid current of air aspirated through the flask.
8	6	White mouse.		600	48.°		7			
9	6	"	22		19.5°	76.59 % O. 23.41 % N.	4½ hrs.			Same flask as No. 9. Mouse introduced at death of No. 9.
10	6					90.8 % O. 9.2 % N.	20 min.	22.36	39.44	
11	9		16		19.°		4½ hrs.			Same flask as No. 11. After death of No. 11.
12	9					90.8 % O. 9.2 % N.	2	25.20	47.26	
13	" 9	Gray mouse.	21		13.°		3¾			After death of No. 13.
14	9	"			20.°		26 min.	28.01		
15	10	White mouse.	18		50.°	90.8 % O. 9.2 % N.	3½ hrs.			
16	10	"	21		39.5°		1½	19.34	55.03	After death of No. 15
17	10		16		-4.5°	90.8 % O. 9.2 % N.	54 min.			After death of No. 17
18	10		22		-1.0°		40 "	24.93	60.65	
19	13		12		18.	Air.	2½ hrs.			After death of No. 19
20	13		13		18.		1 min.	14.47	4.07	
21	13		12		-4.0°	Air.	55 "			After death of No. 21
22	13		13		-7.5°		34	10.76	7.45	

An interesting condition noted in autopsies upon a number of the animals that succumbed to the conditions in the "Richardson" experiment was that of the blood in the heart of the animal. In the cases where death supervened in a short time, the heart blood was fluid and seemed to lack the power of coagulation, while in those cases in which death resulted after several hours' confinement in the flask, the cavities of the heart contained firm, dark clots of blood. This condition of the blood was, no doubt, due to the influence of the CO₂ generated by the animal during the experiment.

CHART I.—SHOWING RELATIVE PROPORTIONS OF CO₂ AND OF O, AND THE RELATIVE DURATION OF LIFE IN THE EXPERIMENTS IN CLOSED VESSELS.

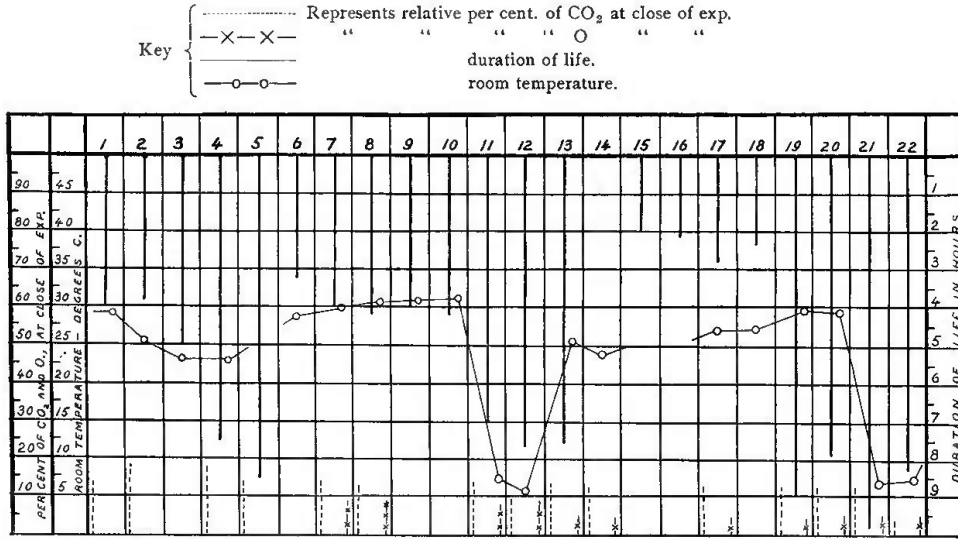

Chart I. shows the relative duration of life, the relative proportions of CO₂ and of O at death of the animal, in the experiments with animals in closed vessels containing atmospheric air.

CHART II.—SHOWING RELATIVE DURATION OF LIFE, PROPORTIONS OF N AND O AT BEGINNING OF EXPERIMENTS, WITH THE TEMPERATURE OF THE ATMOSPHERES IN THE "RICHARDSON" EXPERIMENTS.

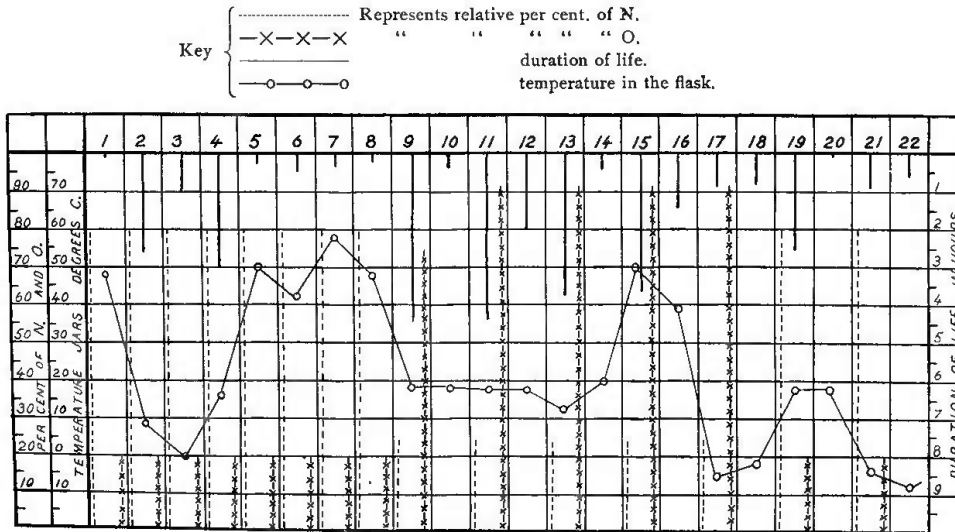

Chart II. shows the relative duration of life, the relative proportions of N and of O at the beginning of each of the "Richardson" experiments, also the temperature curve for the entire series.

THE COMPOSITION OF EXPIRED AIR,

TABLE K.
EXPERIMENTS WITH ARTIFICIAL ATMOSPHERES.

No.	Date.	Animal.	Weight.	Capacity of jar.	Before experiment.			Time of experiment.	After experiment.			Respiratory Quotient $\frac{\text{CO}_2}{\text{O}_2}$.
					% CO ₂ .	% O.	% N.		% CO ₂ .	% O.	% N.	
	1894.		Grams.	c.c.								
1	April 30	Mouse.		2280		4.90	95.10	30 sec.	.02	4.40	95.40	0.0045
2	" 30	"		"		84.00	16.00	1 1/4 hrs.	20.00	58.73	16.91	0.3405
3	May 25	Rabbit.	1920	37,000	.04	20.7	79.26	5 1/4 "	14.87	4.09	81.04	3.6356
4	June 6	Guinea-pig.	473	4000	.04	20.7	79.26	1 1/2 "	15.26	4.29	80.45	3.5571
5	" 4	"	565	"	.68	5.39	93.93	43 min.	8.50	2.31	89.19	3.6796
6	May 5	Mouse.		2280		83.97	16.03	13 3/4 hrs.	25.83	58.65	14.76	0.4404
7	" 5	"		"		83.97	16.03	15 1/4 "	21.06	61.78	17.16	0.3408
8	" 21	"	18			11.35	88.65	3 1/2 "	6.56	4.14	89.30	1.5845
9	" 21	"	15			11.35	88.65	4 1/2 "	7.43	3.58	89.00	2.0754
10	" 21	"	17			11.35	88.65	4 1/2 "	7.52	3.16	89.22	2.3797
11	" 21	"	8 1/2			9.05	90.95	6 1/2 "	5.41	3.34	91.25	1.6197
12	" 21	"	8 1/2			9.05	90.95	10 1/2 "	4.51	2.84	92.65	1.5880
13	" 21	"	11			9.05	90.95	6 3/4 "	5.17	2.87	91.96	1.8013
14	" 28	"	16			8.23	91.77	4 "	4.18	2.52	93.30	1.6587
15	" 28	"	8			8.23	91.77	1 min.	.63	6.48	92.89	0.0972
16	" 28	"	15			8.23	91.77	3 1/2 hrs.	3.85	2.54	94.61	1.5157
17	June 1	"	22			5.70	94.30	4 min.	.58	4.91	94.51	0.1181
18	" 1	"	17			5.70	94.30	2 "	.77	5.40	93.83	0.1425
19	May 26	"	12			5.70	94.30					
20	" 24	"	10		.58	5.40	94.02	3 min.				
21	" 24	"	8		.58	5.40	94.02	2 "				
22	" 24	"	8		.58	5.40	94.02	2 1/2 "	.79	5.75	93.46	0.1273
23	June 1	"	11		12.03	21.61	66.36	8 1/2 hrs.	18.91			
24	" 1	"	10		12.03	21.61	66.36	8 1/2 "	21.02			
25	April 29	"			13.40	3.70	82.90	30 sec.	13.40	3.70	82.90	3.6216
26	May 10	"			14.65	22.00	63.35	7 hrs.	24.65	11.40	64.95	2.1622
27	" 10	"			14.65	22.00	63.35	8 1/2 "	25.10	10.00	64.90	2.5100
28	" 10	"			14.65	22.00	63.35	8 1/2 "	28.30	7.40	64.30	3.8243
29	" 11	Rabbit.	1357	37,000	11.28	19.64	69.08	8 1/2 "	19.16	4.27	75.57	4.4871
30	" 15	"	1750	"	22.40	22.30	55.30	5 "	20.19	4.80	75.01	4.2062
31	" 15	Mouse.		2280	21.00	12.00	67.00	2 "	19.70	8.93	71.37	2.2060
32	" 15	"		"	21.00	12.00	67.00	2 3/4 "	20.00	8.41	71.57	2.3781
33	" 15	"		"	21.00	12.00	67.00	5 1/2 "	21.80	6.54	71.66	3.3333
34	" 4	"		"	21.95	16.65	61.40	5 2 min.	21.45	15.70	62.85	1.3662
35	" 4	"		"	21.95	16.65	61.40	2 1/2 hrs.	23.15	12.815	6.3985	1.8064
36	" 4	"		"	21.95	16.65	61.40	4 1/2 "	22.60	11.43	65.87	1.9772
37	June 8	Rabbit.	1400	37,000	17.00	13.82	69.18	7 1/2 "	16.14	2.97	81.69	5.4343
38	" 9	Guinea-pig.	478	4000	15.00	21.00	64.00	1 1/4 "	16.07	2.77	81.96	5.8014
39	" 11	Grayrat.	Full grown.	37,000	17.81	3.88	88.25	1 1/4 "	11.13	8.55	80.32	1.3017
40	May 31	Mouse.	21	2280	25.47	18.00	56.63	1 1/2 "	27.11	16.20	52.69	1.6734
41	" 31	"	19	"	25.47	18.00	56.53	1 3/4 "	27.47	17.53	55.00	1.5670
42	" 31	"	16	"	25.47	18.00	56.53	1 3/4 "	27.42	16.83	55.75	1.6292
43	June 11	Guinea-pig.	758	4000	30.00	21.00	49.00	1 "	17.83	2.77	79.40	6.4368
44	" 12	Grayrat.	Half grown.	37,000	37.50	22.50	40.00	1 1/2 "	17.25	4.63	78.12	3.7257
45	" 13	Rabbit.	2255	37,000	56.75	43.25		5 "	20.40	3.71	75.89	5.4986
46	" 13	Guinea-pig.	742	4000	62.50	21.25	16.25	1 1/2 "	27.60	4.39	68.01	6.2870
47	" 12	Mouse.		2280	81.36	18.64		1 min.	81.36	18.64		4.3648
48	" 12	"		"	81.36	18.64		1 "	81.36	18.64		4.3648

In order to ascertain whether an atmosphere which had served for respiration, once or oftener, affected an animal differently from an atmosphere made up artificially from pure gases to the same proportions as found in the analysis of the atmospheres in the different experiments reported on, a series of experiments was undertaken to determine the effects of gaseous mixtures made up of varying proportions of CO_2 , O, and of N. The results obtained in this series of experiments are shown in Table K, giving the capacity of the jar, the weight of the animal, the composition of the atmosphere before and after the experiment, and the duration of life in such an atmosphere. The construction of artificial atmospheres, and the introduction of an animal into such an atmosphere without considerable alteration of the proportions of the different gases, through the accidental introduction of atmospheric air, was not always found an easy matter. The chief difficulty was unfortunately a fundamental one, in that the CO_2 was not entirely free from atmospheric air; the oxygen contained more than 10 per cent. of N; while the attempt to obtain pure N from atmospheric air by means usually employed for this purpose—burning out the O with phosphorus—gave variable results with each attempt, the proportion of O remaining after the absorption of the P_2O_5 usually ranged from 2 to 5 per cent. Under these circumstances it will be seen that there was an almost insurmountable difficulty to the construction of an atmosphere having the exact proportions of the different gases predetermined for it, and abundant evidence of this difficulty was obtained from analyses of the mixtures after sufficient time had been allowed, as was supposed, for the diffusion of the gases.

The thorough diffusion of the components of gaseous mixtures appears to be a slow process. Twenty four hours, or longer, was usually allowed for this to take place, yet from the variable lengths of time during which animals of the same size and apparently possessing the same amount of vitality could survive in atmospheres of equal volume made up from the same mixture, and the variable proportions of the different gases found on analysis after death of the animals exposed to these atmospheres, show that perfect diffusion had not always taken place. These discrepancies in the construction of the gaseous mixtures are to be regretted, though they are not great enough to vitiate the value of the experiments taken as a whole. The positive character of the results is too evident to allow these difficulties to have much weight.

There is an uncertain feature in the determinations of the proportions of CO_2 in the gaseous mixtures, after death of the animal, in those instances where this gas was originally present in high percentages. On this account it would be well to bear in mind that the third column representing the proportions of the different gases present at death, marked N, represents, in fact, the gases which failed to be absorbed in the gas-burette by the solutions of caustic soda and of pyrogallic acid used to absorb the CO_2 and O present. There is no doubt as to the presence of the proportions of CO_2 , as stated in the different experiments, before placing the animal in the mixture. Whether a large proportion of the CO_2 was likewise absorbed by the animal, it is impossible to say. There is no probability that such was the case. A part of the loss of CO_2 may also be accounted for in the method employed in making the gaseous mixtures. These mixtures were made by displacing water from the jars which were to contain them. The water may have taken up the CO_2 more readily than the other gases, especially where this was the first gas introduced into the jar, and may, therefore, have been a slight source of variation in the composition of the mixture; yet, it seems, from analysis made just before placing the animal in the mixture, that the loss in this manner was very small. The desired proportion of CO_2 was usually present, even after twenty-four hours had been allowed for diffusion to take place.

Chart III. shows the results obtained in these experiments as to the relative duration of life and the relative proportions of CO_2 and of O at the beginning of the experiment, as well as at death of the animal. In comparing this chart with Chart I., it must be remembered that in this series of experiments the composition of the atmosphere was a different and variable one, while in the series of experiments shown in Chart I., the composition of the atmosphere at the beginning of the experiment was invariably the same—*i. e.*, atmospheric air. This fact, along with the variations in size of jar for different animals, explains the longer or shorter duration of life in this series of experiments as compared with that presented in Chart I. The very important influences of these

The heart invariably contained large, firm blood-clots, dark in color, extending from the auricles into the ventricles. This was usually most marked on the right side.

Microscopic examination of the organs, hardened in alcohol and mounted in celloidin, presented no other constant conditions than those brought about by the mode of death—the extensive venous engorgement. The very slight pathological changes noted in isolated cases, from the rapidity with which death ensued on exposure to the atmospheric conditions present, must be attributed to causes antedating the time of the experiment by a considerable period. The changes here referred to were mostly of the nature of interstitial changes present in the liver and kidneys. No trace of the poisonous effects of any other respiratory products was noted in any of the animals examined.

The results obtained strengthened to a satisfactory degree the conclusions drawn from the results obtained in the other experiments reported on. It was shown that in the absence of a sufficient proportion of O in the artificial gaseous mixture to support life—at least 5 per cent.—the animal speedily succumbed. On the other hand, CO₂ could be present in quite large proportions, as long as sufficient O was also present to support life for some time, and no untoward effects were manifested. The different animals used in these experiments—sparrows, rats, mice, guinea-pigs, and rabbits—manifested no distinct differences in susceptibility to the conditions present.

VI.—Experiments in the inoculation of animals with the moisture condensed from the exhaled breath, as conducted by Brown-Séguard and d'Arsonval, by Hofmann-Wellenhoff, and others. Four series of animals were inoculated with the fluid as shown in Table L.

SERIES I.—The fluid, clear, limpid in character and without odor, of which 21 c. c. had been collected from the breath of a healthy person on December 5, 1893, was warmed by holding the receptacle containing it in a vessel of warm water, about 35° C. A rabbit, weighing 1870 g., received 1½ c. c. into the large vein at the margin of the ear. Another rabbit, weighing 1820 g., also received 1½ c. c. in the same manner. A guinea-pig, weighing 220 g., received 4½ c. c. into the peritoneal cavity. A second guinea-pig, weighing 280 g., also received 4½ c. c. into the peritoneal cavity. A third guinea-pig, weighing 220 g., received 4½ c. c. of sterilized distilled water into the peritoneal cavity as a control.

These animals were kept under careful observation for more than a month, and as nothing unusual in their condition presented itself, they were released.

SERIES II.—On January 18, 1894, 20 c. c. of the fluid had been condensed from the breath of the man having the tracheal fistula. The fluid was warmed by holding the receptacle containing it in a vessel of warm water, about 36° C.

Of this fluid 5 c. c. were injected into the peritoneal cavity of each of three white rats; a fourth rat receiving 5 c. c. of sterilized distilled water into the peritoneal cavity as a control experiment.

INOCULATIONS WITH CONDENSED FLUID OF EXPIRED BREATH.

TABLE L.

SERIES I.

No.	Date.	Animal.	Weight.	Amount of fluid injected.	Remarks.
1	1893 Dec. 5	Rabbit	Grams. 1870	1½ c.c.	Under observation over a month. Healthy.
2	"	"	1820	1½ "	
3	"	Guinea-pig	220	4½	Control—inoculated with sterilized distilled water.
4	"	"	280	4½	
5	"	"	220	4½	

THE COMPOSITION OF EXPIRED AIR,

SERIES II.

1	1894 Jan. 18	White rat	195	5 c.c.	Still alive and healthy.
2	"	"	140	5 "	Died 9-6, 1894, from other causes.
3			148	5	Still alive and healthy.
4			112	5	Control—inoculated with sterilized distilled water.

SERIES III.

2	Feb. 2	Rabbit	1500	7½ c.c.	Killed after 48 days.
3	"	"	2150	10 "	Still under observation. Healthy.
			880	5	Died after 28 days.
4			900	5	Control—inoculated with sterilized distilled water.

SERIES IV.

1	Mch. 30	Rabbit	1161	10 c.c.	Still under observation. Healthy.
2	"	"	1400	10 "	Killed 11-2, 1894. Healthy.
3			1759	10	" " " "
4			1359	10	Still under observation. Healthy.

These animals were under close observation for several months without noting any alteration in their condition. One of them has since died (Sept. 6, 1894) from other causes. The others continue well.

SERIES III.—On February 1, 1894, 44 c.c. of the fluid had been collected from the exhalations of the man having the tracheal fistula. This fluid was again warmed, as before, to about 35° C., and injected into the peritoneal cavity of rabbits as follows:

No. 1.	Weight, 1500 g.,	7.5 c.c. of fluid.
No. 2.	" 2150 g.,	10.0 c.c. " "
No. 3.	880 g.,	5.0 c.c.
No. 4.	900 g.,	5.0 c.c. " sterilized distilled water.

Rabbit No. 3 of this series died during the night of March 4, 1894, and an autopsy held the next morning showed the following conditions*:

Young female rabbit. Externally: Not very thin, adipose not quite used up. Internally: On opening the abdominal cavity the organs were found in normal position. Stomach and large intestines well filled. Liver slightly enlarged, no spots; shows lobular appearance well marked; rather pale in color, as are all the organs and tissues (albino). Gall bladder well filled with pale bile. Small intestines moderately filled; no change in their appearance; Peyer's patches not enlarged. Appendix not inflamed. Spleen not enlarged. Kidneys normal in size. Adrenals small. Lungs normal, rather pale. Heart rather pale, contracted on left side, right side filled with blood.

Cultures were taken from the liver, spleen, blood, and abdominal fluid and all proved negative.

Microscopic examination of the organs: Kidney: Presents some blood-vessels which contain an increased amount of white blood corpuscles. Glomeruli are slightly swollen, showing a small

* Autopsy made by Dr. Olmsted.

amount of infiltration. Slight increase of connective tissue between the tubules. Large blood-vessels are very much dilated. Areas of slight extravasation. A certain amount of cloudy swelling. Liver—Shows large number of small areas of cell-death—necrotic areas. Breaking up of cells and fragmentation of the nuclei, which is almost identical with the conditions found in diphtheria. Adrenals—No change apparent. Spleen—No change apparent. The teased heart muscle, treated with acetic acid, shows possibly a trace of fatty degeneration. No "widespread ecchymoses and hemorrhages in the lungs and intestines" were found, as reported by Brown-Séquard and d'Arsonval.

On March 20, 1894, rabbit No. 1 of this series was killed in order to study the condition of its organs and compare the results with the conditions found in rabbit No. 3. Weight before death, 1830 g., gain 330 g. It seemed to be in perfect health.

On opening the abdominal cavity the organs were found in normal position. No increase of peritoneal fluid. On the liver a number of points (psorosperms?), one a depression $\frac{1}{2}$ mm. in depth, grayish-white in appearance, were noted; mostly on the left lobe. Several other small areas—whitish in appearance, sharply limited in their outline, smaller than the last, not distinctly depressed, usually two, three, or more together—were found scattered over the upper and lower surfaces of the liver. The liver is dark in color, lobules well marked out; of about normal size and consistency. Cutting into the liver there is the usual amount of hemorrhage. Spleen—Small, if anything, it is contracted, otherwise of normal appearance. Adrenals appear normal. Kidneys—Embedded in usual amount of fat. Normal in size, color, and consistency. Small echinococcus cyst in the great omentum, and another in the liver. Intestines normal in appearance. Heart normal in appearance. Portion of muscle teased with salt solution and treated with acetic acid shows no fatty change. Lungs normal in appearance.

Cultures were taken from the peritoneal fluid, liver, spleen, kidneys, and blood. All proved negative.

Microscopic examination of the organs: Liver—Contains a small hemorrhage at the depressed part noted at autopsy. The other spots noted are found to be entirely superficial. Slight increase of connective-tissue elements. Engorgement of a capillary noted. Kidney—Nephritis manifested by some congestion of vessels, proliferation of the connective-tissue cells between the tubules and around the glomeruli; an occasional glomerulus being quite contracted. Spleen shows an increased amount of pigment.

The remaining rabbits of this series have continued well to the present time.

Series IV.—On March 30, 1894, 45 c. c. of the condensed fluid had been collected from the breath of a healthy person. This was again warmed to 35° C., and injected into the peritoneal cavities of four rabbits, each receiving 10 c. c. of the fluid; their weights were as follows: 1161 g., 1359 g., 1400 g., and 1759 g.

On November 2, 1894, the rabbits of this series having remained healthy, Nos. 2 and 3 were killed in order to study the condition of their organs, and determine whether they presented organic lesions traceable to the fluid injected. They were in perfect health as far as might be judged from their appearances.

On *post-mortem* examination all the organs in these animals were found to be normal. Nor was any abnormality to be noted in microscopic examination of the organs.

The remaining animals of this series continue well to the present time.

The pathological conditions noted in the cases of rabbits Nos. 1 and 3 of Series III, are not unusual in these animals, as they are very commonly found in normal animals reared in the laboratory and in those purchased from dealers.* It is unsafe to infer, therefore, that any of the conditions noted in these animals were due to the action of the fluid injected.

The sterility of the fluid injected into the animals in this series of experiments was tested each time by the inoculation of portions of it into tubes of melted gelatin; these were then hardened according to Esmarch's method. In two instances several colonies of a yellow bacillus, common to

* This fact has also been noted by Dr. Abbott. His observations have not yet been published.

the air of the laboratory, developed in the cultures. In the other instances the cultures remained sterile. The fluid used in these cultures was taken from the portions remaining after the animals were inoculated. This fact, in all probability, accounts for the contaminations noted. There is no evidence that any micro-organisms were carried over in the exhaled breath while collecting the fluids for the inoculations. The nature of the organisms which developed in these cultures indicates that they gained entrance to it while the fluid was being warmed and inoculated into the animals.

VII.—Experiments causing animals to breathe air recently expired by other animals.

These experiments are designated as "Brown-Séguard" experiments. The apparatus used consists of a series of bell jars, four to six in number, connected together by means of glass and rubber tubing, and so arranged that a continuous current of air is conducted through the entire series. The apparatus is shown in Fig. 8. The first animal receives pure air only, the second

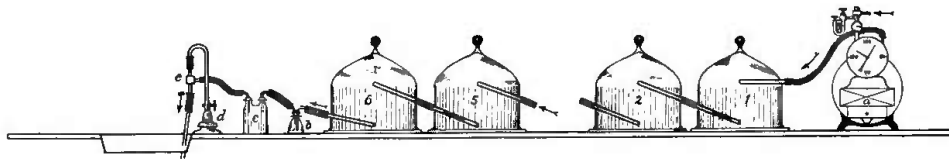

FIG. 8.—Brown-Séguard apparatus.

animal receives the air coming from the bell jar containing the first animal, the third that coming from the second, while the last animal receives air that has traversed the entire series, and, consequently, contains the impurities added to it in its course through all the other jars.

THE "BROWN-SÉQUARD" APPARATUS—FIG. 8.

The Nos. 1, 2, 5, 6 represent four of the six bell jars in the series.

a, represents the gas meter.

b, represents a small Erlenmeyer flask containing about 100 c. c. of water. The bubbles produced by the air passing through the water show whether aspiration is regular or not.

c, represents a Woulff bottle attached between the Erlenmeyer flask and pump to prevent the entrance of water into the apparatus when there is negative pressure in the apparatus.

d, represents the water tap.

e, represents a Chapman water pump, which creates the suction and maintains the ventilation.

The glass and rubber tubing connecting the different parts of the apparatus, as shown in the figure, has an internal diameter of nine mm., while that used to connect the seven-litre bell jars was only five mm. in its internal diameter.

DESCRIPTION OF THE "BROWN-SÉQUARD" APPARATUS—FIG. 8.

The bell jars rest on large ground-glass plates, and, in order to produce an air-tight joint, the base of the bell jar is well rubbed with beef suet (well adapted for this purpose). In addition to this, the joint is sealed with melted paraffine. If this work is carefully done there is no possibility of leakage at these joints. The bell jars are connected together by means of glass tubing bent at right angles and inserted through a perforated rubber cork fitted into the openings near the top and bottom of the jar. The air enters the apparatus through the gas-metre. The metre is connected with the first jar by means of rubber tubing attached to the glass tube inserted into the upper opening of this jar. After passing through this jar it takes its exit by means of the glass tube inserted into the lower opening, and connected with a similar glass tube inserted into the upper opening of the second jar by means of a short piece of rubber tubing. It takes the same course through all the jars.

The bell jars shown in the figure represent those used for the rabbits, and have a capacity of 37,000 c. c. A wooden box, four inches in depth and just large enough to allow the bell jar to be

placed over it, was placed in each of these bell jars. These boxes contained fine dry sawdust to a depth of about five cm., thus forming a comfortable bed for the animals, and at the same time absorbing the urine. In the last experiment (No. 33) it was found necessary to change the sawdust in these boxes every eight to twelve days. When the sawdust was changed each week the animals remained comfortable.

The bell jars used for the mice, sparrows, and guinea pigs were exactly similar in construction to those represented in the figure, but only of 7000 c. c. capacity. For these animals a false bottom of wire netting was placed in the bell jars instead of the boxes with sawdust. This arrangement served to keep the mice and sparrows dry and comfortable, but was less satisfactory with the guinea pigs.

For the mice and sparrows sufficient food and water were placed in the jar at the beginning to last to the close of the experiment. For the guinea-pigs and rabbits this was impossible; these being fed daily on cabbage leaves introduced through one of the openings in the jars. By arresting the aspiration of air through the apparatus for a few minutes there was very little opportunity for any change to take place in the confined air while the animals were being fed.

In order to facilitate the taking of samples of air from the bell jars, a T-tube was inserted between each of the last three jars. The Bunte gas-burette was attached to the stem of one of these T-tubes and the air aspirated from the jar by the force of the water flowing out of the lower opening of the burette. By placing a screw clamp on the rubber connections on either side of the T-tube it was possible to take a sample of air from the jar before or after it, as might be desired. By stopping the aspirating pump there was rarely any difficulty in taking a sample of air from any of the jars in the manner stated. On two or three occasions a slight negative pressure in the jar, caused by the small amount of ventilation taking place, prevented the aspiration of a sufficient amount of air (100 to 150 c.c.) to accomplish its analysis in the burette. Otherwise no trouble was experienced in the taking of samples of air as desired. The gas-burette was connected with the T-tubes by means of a short piece of rubber tubing attached to the stem of these tubes and ordinarily closed with a short glass rod. The rubber tubing was attached to the three-way stopcock of the burette.

The results in the thirty-three experiments performed upon sparrows, mice, guinea-pigs, and rabbits are shown in the following tables.

In these experiments, as well as in those previously reported, the disturbance of the heat-regulating function may have contributed to the results.

Absorbers containing caustic soda or potash, or soda lime, were used in experiments 6 to 14 between the third and fourth, and the fourth and fifth jars of the series to absorb the CO_2 from the air passing into the last two jars. This arrangement failed to save the lives of the animals in these two jars. In experiments 15, 18, and 19, an absorption-tube containing concentrated H_2SO_4 was placed between the last two jars. The results obtained in these three experiments do not differ from those obtained without the H_2SO_4 absorbers, and, therefore, give no evidence whatever of the protective influence claimed for such absorbers. The primary cause of death, low percentage of O, was still present and active.

Experiments 20 to 28 were made with the hope of producing some slight tolerance to the atmospheric conditions present in these experiments on the part of an animal subjected to such conditions for a considerable time. While there is positive evidence that a mouse living under these conditions for several days can withstand an atmosphere that instantly kills a fresh mouse, the number of experiments made are insufficient to prove that such tolerance has any great degree of permanency; yet the results obtained with the mice carried through the series of experiments from 20 to 28 indicate the probability that the tolerance obtained is maintained for at least several days afterward, and that such animal is less likely to die when again quickly placed into such an atmosphere than one that had not had such an experience.

The guinea-pigs used in experiment 30 seemed to be unable to withstand, with equal facility with the mice and sparrows, the atmospheric conditions to which they were subjected. Several of them succumbed to œdema of the lungs during the second week of the experiment, but since this

is the only experiment in which these animals were used, a positive opinion on this point cannot be given.

The rabbits in experiment 31 were supposed, at the time, to have succumbed to the oppressive heat of the laboratory owing to the season of the year, but the later experiments would indicate an insufficient amount of air was aspirated through the bell jars, and it is evident that leakage took place through some of the connections because of the irregular order in which death took place.

The last experiment was made to determine what the results would be when the proportion of CO_2 was kept as low as Brown-Séquard and d'Arsonval claim for their experiments. It was found impossible to aspirate sufficient air per hour to bring about this result. However, sufficient air was aspirated to prevent the reduction of the O to proportions that were insufficient to support life. By this means it was possible to continue the experiment for six weeks without losing any of the animals, or producing any grave symptoms in any of them.

In this experiment mercurial manometers were attached between the first and second, and between the fifth and sixth bell jars to ascertain the amount of negative pressure, if any, brought about by the conditions or by the form and arrangement of the apparatus. A difference of about three millimetres was noted between the fifth and sixth bell jars, while no difference was noted between the first and second. It was also ascertained, by placing a clamp on the rubber tubing connecting the fifth and sixth jars, and continuing the aspiration, that the amount of negative pressure required to break one of the glass plates on which the jars rested, as occurred in experiment 32, was 105 millimetres. From this it may be inferred that at times a greater negative pressure existed than that noted in the last experiment. Such extreme negative pressure as was found necessary to break a glass plate 45 x 45 x 0.6 centimetres could only occur upon the entire arrestation of the air-current from some accident to the apparatus. Under ordinary circumstances we do not believe that the amount of negative pressure differed to any extent from that found in the last experiment.

The proportions of CO_2 and of O present at the time of death bear a constant relation to each other in the different experiments. The duration of life in each instance was dependent entirely upon the rapidity of the air current circulating through the apparatus. This statement, however, requires further explanation. If the average rate of ventilation per hour for an entire experiment is taken, it will be found to vary considerably in the different experiments. This is evident when it is stated that in experiment 7 the rate had been 9.8 litres per hour up to the time of the death of the animal in the third jar; in experiment 8 the rate had been 3.8 litres per hour at the death of the fifth animal; in experiment 9 the rate had been 11.9 litres per hour at the death of No. 5; at the death of No. 3, in experiment 14, 10.2 litres per hour; at the death of Nos. 3, 4, and 5, in experiment 15, 3.45 litres per hour; at the death of Nos. 3, 4, and 5, in experiment 16, only 1.9 litres per hour; at the death of No. 5, in experiment 19, 3.55 litres per hour. From these figures it will be seen that the average rate of ventilation per hour for an experiment is not the most important factor. By referring to the tables giving the details for each of the 33 experiments it will be noted that the rate of ventilation was frequently changed. It was usually increased considerably in the evening and again decreased the next morning. Frequent changes in the rate during the day were also necessary, because it is practically impossible to get a perfectly steady current with the water pump. In carefully regulating the rate of ventilation, the lives of the animals were controlled at will, and it is upon the rapidity of the air-current toward the close of the experiment that the duration of life depended in each case.

The rabbits used in the last "Brown-Séquard" experiment were weighed at the end of the experiment and their weight then as compared with their weight at the beginning of the experiment was as follows:

No. 1,	before	820 g.,	after	1052 g.,	gain	232 g.
" 2,	"	900 g.,	"	1055 g.,	"	155 g.
3,		917 g.,		1190 g.,		273 g.
4,		1125 g.,		1047 g.,	loss	78 g.
5,		1220 g.,		1352 g.,	gain	132 g.
6,		1665 g.,		1544 g.,	loss	121 g.

At the death of No. 4, six days after the close of the experiment, the loss in its weight was found to have been caused by the presence of psorosperms in its liver. This organ was literally filled with masses of these bodies. The loss of weight in No. 6, in the absence of any other observable causes, may be safely attributed to its position in the series of bell jars, and, therefore, to the impurity of the atmosphere which it breathed. The estimations of the proportions of CO₂ and of O present in this bell jar, as found from day to day, denote atmospheric conditions that were undoubtedly unfavorable to the full performance of its bodily functions. It ate less ravenously than the other animals and was frequently in a stupid, drowsy condition.

At the close of this experiment an examination of the blood of these rabbits was also made and the proportion of corpuscles per cubic millimetre determined with the Thoma-Zeiss hæmocytometer, with the following results :

No. 1,	5,170,000 red,	and	24,000 white	per cubic mm.
" 2,	5,337,000 "	"	21,000 "	" " "
3,	4,510,000		18,000	
" 4,	4,150,000		10,000	
5,	4,950,000		15,000	
6,	4,375,000		16,000	

Here again there is evidence that the conditions existing in these bell jars were injurious to some extent ; most so in the last jars. No. 4 presents evidence of an influence more serious in its nature than that presented by the other animals, and this has since been found to have originated from causes within its own body.

Microcytes were noted in the blood of these animals. These immature corpuscles seemed to be more numerous in Nos. 4, 2, and 1 ; the blood of the other animals presenting only a few of these bodies.

Thirty-eight days after the termination of the experiment a second examination was made of the blood of the five remaining animals, with the following results :

No. 1,	4,400,000 red,	and	20,000 white	per cubic mm.
" 2,	4,500,000 "	"	15,000 "	" " "
3,	5,160,000		30,000	
5,	4,960,000		30,000	"
6,	5,890,000		20,000	

The first and second animals show a slight reduction and the third and sixth an increase in the number of corpuscles. No microcytes or blood-plates were noticed this time.

The weight of these animals at the time of this second examination of the blood was as follows :

No. 1,	1040 g.,	lost 12 g.,	since close of experiment.
" 2,	1045 g.,	" 10 g.,	" " " "
3,	1265 g.,	gained 75 g.,	
5,	1405 g.,	" 53 g.,	
6,	1545 g.,	1 g.,	

The loss of weight in the first and second animals may be due to the change of food. The gain in the others is no doubt due to the better atmospheric conditions under which they are now living.

No. 2. BROWN-SÉQUARD EXPERIMENT.

Commenced at 11.45 A.M., March 3, 1894. Sparrows in 7-litre bell jars. 5 in series.

Time.	No. 1. 21 g.		No. 2. 21 g.		No. 3. 21 g.		No. 4. 21 g.		No. 5.		Remarks.
	CO ₂ .	O.	CO ₂ .	O.	CO ₂ .	O.	CO ₂ .	O.	CO ₂ .	O.	
4 $\frac{3}{4}$ hrs.										+	36.8 litres aspirated. No. 5 died. No. 4 died during night. Others lively. No. 3 still comfortable. No. 3 died. Nos. 1 and 2 dead. Examination of air after death of each bird.
19 $\frac{1}{4}$								+			
22						+					
27						+					
29 $\frac{3}{4}$		+									
48 $\frac{1}{4}$			2.85	16.99	5.01	15.65	6.07	12.63	7.36	13.40	

No. 3. BROWN-SÉQUARD EXPERIMENT.

Commenced at 12.15 P.M., March 5, 1894. Sparrows in 7-litre bell jars. 5 in series.

Time.	No. 1. 22 g.		No. 2. 19 g.		No. 3. 27 g.		No. 4. 26 g.		No. 5. 25 g.		Remarks.
	CO ₂ .	O.	CO ₂ .	O.	CO ₂ .	O.	CO ₂ .	O.	CO ₂ .	O.	
20 $\frac{3}{4}$ hrs.											Current 11.6 litres per hour. Current reduced; now 6 litres per hour. No. 5 died. Nos. 3 and 4 dead. Experiment stopped.
22 $\frac{1}{2}$ "											
29 $\frac{1}{2}$										+	
29 $\frac{3}{4}$						+		+			

No. 4. BROWN-SÉQUARD EXPERIMENT.

Commenced at 9.30 A.M., March 7, 1894. Sparrows in 7-litre bell jars. 5 in series.

Time.	No. 1. 21 g.		No. 2. 22 g.		No. 3. 23 g.		No. 4. 25 g.		No. 5. 21 g.		Remarks.
	CO ₂ .	O.	CO ₂ .	O.	CO ₂ .	O.	CO ₂ .	O.	CO ₂ .	O.	
13 $\frac{3}{4}$ hrs.		+		+		+		+		+	All the birds are dead. No record of amount of air aspirated. Examination of air after death.
			14.30	4.485	14.01	3.635					

No. 8. BROWN-SÉQUARD EXPERIMENT.

Commenced at 3.45 P.M., March 14, 1894. Sparrows in 7-litre bell jars. 5 in series.

Time.	No. 1. 29 g.		No. 2. 23 g.		No. 3. 27 g.		No. 4. 26 g.		No. 5. 27 g.		Remarks.
	CO ₂ .	O.	CO ₂ .	O.	CO ₂ .	O.	CO ₂ .	O.	CO ₂ .	O.	
18 hrs.											106 litres aspirated. Birds all well.
19½							4.28	7.73	4.52	7.12	Nos. 3 and 4 showing signs of oppression.
20¾											No. 5 most affected.
30							4.82	5.01	3.27	3.95	No. 5 died. 121.75 litres aspirated. No. 4 quite sick.
31¼										+	Nos. 3 and 4 died in night. 141.5 litres aspirated and experiment stopped.
47¼					8.56	9.665*	0.96	10.06*	2.875	3.56	Examination of air after death.

No. 9. BROWN-SÉQUARD EXPERIMENT.

Commenced at 11.30 A.M., March 16, 1894. Sparrows in 7-litre bell jars. 5 in series.

Time.	No. 1. 29 g.		No. 2. 23 g.		No. 3. 26 g.		No. 4. 24 g.		No. 5. 24 g.		Remarks.
	CO ₂ .	O.	CO ₂ .	O.	CO ₂ .	O.	CO ₂ .	O.	CO ₂ .	O.	
4½ hrs.							.001036	13.37	.001047	12.67	CO ₂ absorbers. 39.6 litres aspirated.
6½											Current increased.
22							1.29	16.41	2.01	14.92	290 litres aspirated, or 13 litres per hour. All are well.
22½											357.9 litres aspirated. All birds well.
30						+		+		+	All died during night (aspiration practically nil).
46¾					18.01	1.51	16.68	0.468	13.065	2.545	Examination of air after death.

* These air analyses were made several hours after death, and considerable alteration must have occurred through ventilation in the interval.

NO. 10. BROWN-SÉQUARD EXPERIMENT.

Commenced at 9.15 A.M., March 20, 1894. Sparrows in 7-litre bell jars. 5 in series.

Time.	No. 1. 28 g.		No. 2. 23 g.		No. 3. 27 g.		No. 4. 27 g.		No. 5. 24 g.		Remarks.
	CO ₂ .	O.	CO ₂ .	O.	CO ₂ .	O.	CO ₂ .	O.	CO ₂ .	O.	
3 hrs.											CO ₂ absorbers: all are slightly oppressed.
3 $\frac{3}{4}$ "							3.08	12.24	6.73	12.11	
5 $\frac{3}{4}$							4.27	7.34	2.61	9.04	
6 $\frac{3}{4}$							5.22	6.89	2.86	7.50	
7 $\frac{3}{4}$							5.69	5.69	4.79	5.74	
8											Current increased for the night.
23							1.114	16.49	0.503	15.79	25.5 litres aspirated. All are somewhat oppressed.
24 $\frac{1}{2}$							3.23	12.46	1.20	14.02	All are lively. 360.8 litres aspirated, current reduced.
25 $\frac{1}{2}$							5.60	9.74	3.60	9.88	Becoming oppressed.
26 $\frac{1}{2}$							8.28	8.65	5.27	9.14	
27 $\frac{1}{2}$							7.82	5.65	5.11	7.71	
28 $\frac{1}{2}$							9.08	3.13	6.20	6.84	All are very much oppressed.
29 $\frac{1}{2}$							9.51	+	6.34	5.59	pressed.
30 $\frac{1}{2}$							9.42	4.07	6.42	4.86	No. 4 died.
31				+		+				+	Nos. 3 and 5 died.
32 $\frac{1}{2}$			15.14	3.145	14.34	4.775	10.965	3.50	10.54	3.77	No. 2 died. No. 1 released. Revived; exp. stopped. Examination of air after death.

NO. 11. BROWN-SÉQUARD EXPERIMENT.

Commenced at 11.45 A M., March 22, 1894. Sparrows in 7-litre bell jars. 5 in series.

Time.	No. 1. 28 g.		No. 2. 20 g.		No. 3. 20 g.		No. 4. 25 g.		No. 5. 26 g.		Remarks.
	CO ₂ .	O.	CO ₂ .	O.	CO ₂ .	O.	CO ₂ .	O.	CO ₂ .	O.	
3¼ hrs.							1.41	14.20	0.96	12.98	CO ₂ condensers. No. 3 died. Replaced by a fresh bird, weight 29 g. Experiment continued.
3½					4.86	13.965					
5¼							2.06	11.06	1.28	11.30	34 litres aspirated. Current increased.
20¾											152.8 litres aspirated.
21							1.40	12.92	1.99	12.76	8½ litres per hour during night.
22							1.83	12.02	5.19	9.07	Current reduced.
							2.16	11.11	6.39	7.90	All somewhat oppressed.
23							2.48	9.45	7.30	6.23	
24								+			No. 4 quite sick.
25							2.79	9.34	7.70	5.65	No. 4 died. Nos. 3 and 5 show great oppression.
26									6.93	4.86	
27									6.465	4.29	
									+		No. 5 died.
28									6.76	3.53	
28¼											No. 3 died. No. 2 much oppressed.
											8.5 litres aspirated last 9 hrs. Exp. stopped. Nos. 1 and 2 died during night.
29¾			14.525	4.29	15.09	4.30	3.49	9.545	8.31	3.395	Examination of air after death.

NO. 12. BROWN-SÉQUARD EXPERIMENT.

Commenced at 3.45 P.M., March 24, 1894. Sparrows in 7-litre bell jars. 5 in series.

Time.	No. 1. 24 g.		No. 2. 25 g.		No. 3. 26 g.		No. 4. 27 g.		No. 5. 25 g.		Remarks.
	CO ₂	O.	CO ₂	O.	CO ₂	O.	CO ₂	O.	CO ₂	O.	
hrs.											31 litres aspirated. Current slightly increased.
19											334.5 litres aspirated.
20 $\frac{1}{2}$											All lively. Ba(HO) ₂ absorber renewed.
40 $\frac{1}{4}$											469.75 litres aspirated.
42 $\frac{1}{2}$							5.018	5.947	2.264	6.436	Nos. 3, 4, and 5 oppressed.
43 $\frac{1}{4}$							3.457	5.887	1.577	4.08	486.75 litres aspirated.
44 $\frac{1}{2}$											Current reduced.
46 $\frac{1}{4}$								+			No. 5 died.
47 $\frac{1}{2}$											No. 4 died.
50						+					No. 3 died. 448.75 litres aspirated. No. 2 oppressed.
65 $\frac{3}{4}$											Nos. 1 and 2 oppressed, No. 2 most so.
											Experiment stopped. Both revived. 543.5 litres aspirated.
					14.77	3.412	4.293	1.36	3.729	3.449	Examination of air after death.

NO. 13. BROWN-SÉQUARD EXPERIMENT.

Commenced at 12.45 P.M., March 27, 1894. Sparrows in 7-litre bell jars. 5 in series.

Time.	No. 1. 24 g.		No. 2. 25 g.		No. 3. 26 g.		No. 4. 25 g.		No. 5. 25 g.		Remarks.	
	CO ₂ .	O.	CO ₂ .	O.	CO ₂ .	O.	CO ₂ .	O.	CO ₂ .	O.		
1/2 hrs											8 litres aspirated. Current reduced.	
2 1/2											35 litres aspirated.	
3 1/2							1.12	14.565	0.676	13.636		
5											53 litres aspirated. Current increased for night.	
20 1/4							4.00	11.279	2.827	10.556	249 litres aspirated. All lively.	
21 1/4							4.00	8.279	3.29	7.055	Nos. 3, 4, and 5 becoming oppressed.	
23 1/4											All are much oppressed.	
25							4.644	6.145	3.76	4.524	Current slightly increased.	
26 1/4							1.655	7.685	1.054	5.80	307 litres aspirated. Current increased for night.	
28 1/2											523 litres aspirated. All are well.	
28 3/4												
44 1/4							4.477	11.94	2.468	11.974	566 litres aspirated. Leakage, meter changed to other end of bell jars.	
46 1/4											All showing signs of oppression.	
47							5.365	9.365	3.518	8.60		
47 1/2							4.609	8.45	3.041	7.794		
48 1/2							4.113	7.498	4.03	5.95		
49 1/2							4.938	5.508	4.25	4.54		
50 1/2							4.932	4.545	6.327	3.894		
51 1/2										+	No. 5 died.	
53											Nos. 3 and 4 died.	
54 1/4			+			+					No. 2 died. No. 1 released.	
54 1/2											Experiment stopped.	
			14.746	2.186	13.92	3.912				6.4875	3.4395	Examination of air after death.

NO. 14. BROWN-SÉQUARD EXPERIMENT.

Commenced at 12 M., March 30, 1894. Mice in 7-litre bell jars. 5 in series.

Time.	No. 1. 19.5 g.		No. 2. 20 g.		No. 3. 27 g.		No. 4. 19 g.		No. 5. 27 g.		Remarks.
	CO ₂ .	O.	CO ₂ .	O.	CO ₂ .	O.	CO ₂ .	O.	CO ₂ .	O.	
5 $\frac{3}{4}$ hrs.											26 litres aspirated. Current increased. Nos. 3, 4, and 5 slightly oppressed.
21							.278	13.699	.645	14.76	157 litres aspirated.
22 $\frac{1}{4}$							1.799	14.58	2.034	13.66	No. 3 is slightly oppressed.
24							3.67	11.11	3.357	10.268	161 $\frac{1}{2}$ litres aspirated.
26 $\frac{1}{4}$							3.25	10.143	3.068	9.30	Nos. 3, 4, and 5 slightly oppressed.
27 $\frac{1}{2}$							2.975	9.213	2.777	8.908	
28 $\frac{1}{4}$							2.495	8.06	2.013	5.656	
29											
30											166 litres aspirated. Current increased. All more or less oppressed.
46											393 litres aspirated. All still oppressed. Current reduced.
69 $\frac{1}{2}$										+	413 litres aspirated. No. 5 died in night. Others very sick.
71											No. 3 died.
71 $\frac{1}{2}$											414 litres aspirated.
											No. 4 died.
73 $\frac{1}{4}$											415.5 litres aspirated.
76					12.40	3.53	5.476	3.277	7.176	4.53	Aspiration stopped. 417 litres aspirated. Examination of air after death.

NO. 15. BROWN-SÉQUARD EXPERIMENT.

Commenced 12 M., April 2, 1894. Mice in 7-litre bell jars. 5 in series.

Time.	No. 1. 19.5 g.		No. 2. 17 g.		No. 3. 18 g.		No. 4. 17 g.		No. 5. 17 g.		Remarks.
	CO ₂ .	O.	CO ₂ .	O.	CO ₂ .	O.	CO ₂ .	O.	CO ₂ .	O.	
15 hrs.					3.839	15.356	8.671	8.671			2 litres aspirated.
15½ "					7.865	9.55	6.39	5.534	5.75		Leakage.
17							7.41	5.357		9.93	
18							7.69	5.38	6.45	9.248	5.0 litres aspirated.
19¼											5.5 litres aspirated.
19½											17 litres aspirated.
22											19.5 litres aspirated. Current increased.
23											109 litres aspirated.
39							1.765	13.84	1.78	14.39	
40½							2.40	13.16	2.39	12.517	
41½							3.72	12.51	3.717	11.639	
42¼							3.867	11.22	5.048	10.00	
44							5.05	9.53	5.57	8.406	
45¼							5.17	9.79	3.78		142.5 litres aspirated.
46¼										...	142.5 litres aspirated.
47¼											
62½							6.845	8.60	1.98	6.06	All somewhat oppressed.
63¼							7.49	7.67	2.35	4.70	183 litres aspirated.
64½							7.29	7.29	3.03	3.98	185 litres aspirated.
65¼							7.40	6.37	3.59	3.96	All considerably oppressed.
66¼							7.75	5.86	2.92	3.86	
67½							7.319	6.178	3.26	3.58	
68½							7.27	6.04	3.43	3.33	
69½							8.22	5.10	3.03	2.15	
70¼							8.25	4.78	4.00	2.96	
71							7.61	5.39	3.44	3.25	
71¼											Current increased; 189.5 litres aspirated. <i>All much oppressed.</i>
86¼							3.60	12.93	2.35	13.65	All quite lively; 367 litres aspirated. All absorbers renewed.
87¼							5.248	12.58	3.19	12.77	
88½							5.456	12.32	4.14	12.15	
89½							7.47	10.34	5.465	10.546	All absorbers acting poorly.
90¼							7.66	9.875	6.22	9.707	
92¼							8.37	9.335	6.346	9.519	
93¼							9.17	8.508	7.66	8.141	
94¼							9.67	7.375	8.365	7.307	
95¼							9.93	7.35	8.318	7.68	373 litres aspirated. Current slightly in- creased.
96				+	+		+		+		Nos. 2, 3, 4, and 5 dead; 382 litres aspirated. Experiment stopped.
110½ "			10.939	6.52	12.60	4.55	12.28	3.93	12.31	4.86	Examination of air after death of mice.

No. 16. BROWN-SÉQUARD EXPERIMENT.

Commenced at 10 A.M., April 9, 1894. Mice in 7-litre bell jars. 5 in series.

Time.	No. 1. 7 g.		No. 2. 15 g.		No. 3. 18 g.		No. 4. 25 g.		No. 5. 19 g.		Remarks.
	CO ₂ .	O.	CO ₂ .	O.	CO ₂ .	O.	CO ₂ .	O.	CO ₂ .	O.	
7½ hrs.											7.5 litres aspirated. All oppressed. Current increased.
22¾											81.5 litres aspirated. Current reduced.
31½											86 litres aspirated. All except No. 1 oppressed. Current increased.
47						+		+		+	90.5 litres aspirated. Nos. 3, 4, and 5 died in night. The experiment stopped.
					16.317	3.80	13.30	4.02	12.05	5.437	Examination of air after death.

No. 17. BROWN-SÉQUARD EXPERIMENT.

Commenced at 12 M., April 11, 1894. Mice in 7-litre bell jars. 5 in series.

Time.	No. 1. 7 g.		No. 2. 15 g.		No. 3. 16 g.		No. 4. 23 g.		No. 5. 17 g.		Remarks.
	CO ₂ .	O.	CO ₂ .	O.	CO ₂ .	O.	CO ₂ .	O.	CO ₂ .	O.	
5 $\frac{1}{4}$ hrs											9.5 litres aspirated. All slightly oppressed. Current increased.
21 $\frac{1}{2}$ "											47 litres aspirated. Current reduced somewhat.
30											53.5 litres aspirated. All oppressed; current again increased.
44 $\frac{1}{4}$											122.5 litres aspirated; all lively again.
51 $\frac{1}{2}$							13.48	8.80	12.118	8.325	
52 $\frac{1}{2}$							12.129	7.067	12.645	7.41	
53											131.5 litres aspirated. All more or less oppressed. Current increased.
68											179 litres aspirated. All lively again. Current considerably reduced.
68 $\frac{1}{2}$							11.346	7.88	12.78	6.92	
69 $\frac{1}{2}$							12.09	7.38	12.75	6.519	
71 $\frac{1}{2}$							12.007	7.49	13.35	5.76	
72 $\frac{1}{2}$							13.66	6.256	14.285	6.405	
75							15.13	4.59	15.13	4.36	
76							15.08	4.13	15.26	3.86	
77							15.613	3.83	15.91	3.47	186.5 litres aspirated. Current increased. All oppressed.
79 $\frac{1}{2}$ "											293.5 litres aspirated. All are lively again.
104 $\frac{1}{4}$											Current somewhat reduced for the next 24 hours.
117 $\frac{1}{2}$							10.919	7.00	11.11	6.536	
118 $\frac{1}{2}$							10.919	7.08	11.73	7.00	
119 $\frac{1}{2}$							11.068	6.297	11.74	5.68	
121 $\frac{1}{2}$							11.11	5.465	12.535	5.22	
122 $\frac{1}{2}$							12.63	4.689	12.737	4.94	
123 $\frac{1}{2}$							12.65	4.506	13.08	4.17	360.5 litres aspirated. All show considerable depression.
124 $\frac{1}{2}$							12.989	4.29	13.96	3.77	
121 $\frac{1}{4}$										a	
122 $\frac{1}{4}$										b	Mice are much oppressed. The experiment is now stopped. All revived. 364.5 litres aspirated.
125										c	
125										d	
125											
125 $\frac{1}{4}$											

- a. Fresh house mouse placed in No. 5 jar. Died in two minutes.
- b. " white " " " 5 " Lived to end of experiment.
- c. " " " " " 5 " Died in half a minute.
- d. " " " " " 4 " Died in half an hour.
- 3 " " " " " 3 " Died in six minutes.

NO. 18. BROWN-SÉQUARD EXPERIMENT.

Commenced at 9.45 A.M., April 17, 1894. Mice in 7-litre bell jars. 5 in series.

Time.	No. 1, 14 g.		No. 2, 23 g.		No. 3, 23 g.		No. 4, 25 g.		No. 5, 31 g.		Remarks.
	CO ₂ .	O.	CO ₂ .	O.	CO ₂ .	O.	CO ₂ .	O.	CO ₂ .	O.	
7½ hrs.											8 litres aspirated. All are slightly oppressed. Current increased.
22¾ "											133 litres aspirated. All are lively.
31¾ "											159.5 litres aspirated. Current continued.
49 "											219 litres. All are more or less oppressed
49½ "							11.34	8.93	12.897	7.12	
50¾ "							12.21	7.25	13.77	5.66	
52½ "							13.15	6.278	14.479	4.944	
53¼ "										a	
53½ "										b	
53¾ "										c	
54 "								d			
54 "								e			
54 "								f			
56¼ "							12.94	6.945	13.945	5.46	
65½ "											Experiment stopped. All living; also white mouse placed in No. 5, and small gray mouse in No. 4, as well as mouse d.

a Fresh house mouse in No. 5 ; died in one minute.

b No. 5 of Experiment 16 in No. 5 ; died in one minute.

c White mouse, used in Experiment 16, in No. 5 ; remained alive to end of experiment.

d White mouse, used before, in No. 4 ; remained alive to end of experiment.

e House mouse (fresh) in No. 4 ; remained alive to end of experiment.

f House mouse (large) in No. 4 ; died in two minutes.

No. 19. BROWN-SÉQUARD EXPERIMENT.

Commenced at 10.30 A.M., April 20, 1894. Mice in 7-litre bell jars. 5 in series. H₂SO₄ absorber.

Time.	No. 1, 7 g.		No. 2, 7 g.		No. 3, 7 g.		No. 4, 18 g.		No. 5, 33 g.		Remarks.
	CO ₂ .	O.	CO ₂ .	O.	CO ₂ .	O.	CO ₂ .	O.	CO ₂ .	O.	
6 hrs.											18.5 litres aspirated. All show oppression.
23 "											133.5 litres aspirated. All oppressed. Current reduced slightly.
29 "							7.627	11.716	10.58	8.226	Current the same.
30 "							8.568	10.029	10.69	7.418	144 litres aspirated. All are oppressed. Current increased.
31 "											213 litres; current the same.
47½ "											306.5 litres. All are oppressed. Current reduced.
70¼ "							9.637	9.73	11.238	7.809	
76½ "							9.62	9.15	11.258	7.238	
78½ "											324 litres aspirated. Current increased.
79¼ "											406 litres aspirated. Current reduced.
94¼ "							5.87	13.22	7.70	11.267	
95¼ "							9.159	—	10.87	7.40	
102¼ "											421 litres aspirated. Current the same.
103¼ "											428.5 litres. Nos. 3, 4, and 5 are very sick.
118¾ "										a	
118¾ "										b	
118¾ "										d	
118¾ "										+	No. 5 died.
119 "											The others are very sick, especially No. 4.
120½ "							13.73	4.23	14.12	3.816	
121½ "											No. 4 died. Experiment stopped. Others soon revived.

a No. 4 of last experiment placed in No. 5 jar; died in two minutes.

b White mouse, used in Experiment 17, placed in No. 5 jar; died in two and one-half minutes.

c White mouse, used in Experiment 17, placed in No. 4 jar; died in three and one-half minutes.

d Small mouse, used in Experiment 17, placed in No. 5 jar; died in one minute.

THE COMPOSITION OF EXPIRED AIR,

Nos. 20-28. BROWN-SÉQUARD EXPERIMENTS.

Commenced at 2.30 P.M., April 25, 1894; ended at June 5, 1894. Mice in 7-litre bell jars.

5 in series.

Time.	No. 1, 7 g.		No. 2, 15 g.		No. 3, 18 g.		No. 4, 25 g.		No. 5, 19 g.		Remarks.
	CO ₂ .	O.	CO ₂ .	O.	CO ₂ .	O.	CO ₂ .	O.	CO ₂ .	O.	
3 hrs.											9 litres aspirated. Current continued.
18½ "											87.5 litres aspirated. All comfortable.
26½ "											94.5 litres aspirated. All slightly oppressed. Current increased.
43¼ "											139.5 litres aspirated. All depressed. Current reduced.
49½ "											147 litres aspirated. Considerably depressed. Current increased.
68											324.5 litres aspirated. All lively. Current reduced.
75											332 litres aspirated. Current continued.
91¾ "										+ a	355 litres aspirated. No. 5 died; No. 4 greatly depressed.
93											357 litres aspirated. Experiment stopped; all soon revived.

Continued as Experiment 21, after intermission of two days. May 1, 1894.

4¼ hrs.											Fresh mouse in No. 5. 26 litres aspirated. All lively. Current reduced.
19¾ "											145.5 litres aspirated. Current the same.
28¼ "											160 litres aspirated. Current increased, showing depression.
44 "											341.5 litres aspirated. All lively again. Current reduced.
52½ "											351.5 litres aspirated. Depressed. Current increased.
68											459 litres aspirated. All more comfortable. Current reduced.
72 "											466.5 litres aspirated. Experiment stopped.

Continued as Experiment 22, after interval of three days. May 7, 1894.

7 hrs.											12 litres aspirated. All slightly oppressed. Same current.
23½ "											68.5 litres aspirated. All considerably oppressed. Same current.
31 "											76.5 litres aspirated. All much oppressed. Current increased.
47½ "											202.5 litres aspirated. Current reduced slightly.
55½ "											222.5 litres aspirated. Current the same.
71 "									+b		243 litres aspirated. No. 4 died in the night; others oppressed.
71½ "											
72 "											248.5 litres aspirated. Experiment stopped; all soon revived.

Continued as Experiment 23, after interval of three days. May 11, 1894.

6¾ hrs										4	18 litres aspirated. Four mice placed in No. 4.
29¾ "										+	39.5 litres aspirated. Two mice in No. 4 are dead; removed.
46½ "										+	109.5 litres aspirated.
48½ "										+	122.5 litres aspirated.
60½ "											147.5 litres aspirated.
70¾ "						+				+	148 litres aspirated. Two remaining mice in No. 4 died; also No. 3.
70¾ "										+	Experiment discontinued; soon revived.

Continued as Experiment 24, after interval of two days. May 16, 1894.

3 hrs											Fresh mice in Nos. 3 and 4.
23½ "											22.5 litres aspirated. Current continued.
47½ "											121.5 litres aspirated. All lively.
65½ "											211.5 litres aspirated. All more or less oppressed.
71½ "											276 litres aspirated. All more or less oppressed.
74½ "											325 litres aspirated. All more or less oppressed.
											341.5 litres aspirated. Considerably oppressed; experiment stopped.

Continued as Experiment 28, after interval of one day. June 2, 1894.

4½ hrs.										7 litres aspirated. Current increased.
21¾ "										134.5 litres aspirated. Same current.
45										227.5 litres aspirated. Current reduced.
52½										258 litres aspirated. Same current continued.
68¾ "										395 litres aspirated. Current again reduced.
75										434 litres aspirated. Experiment stopped; revived.

a No. 1 of Experiment 17 placed in No. 5; died in one-half minute.
 b No. 3 of Experiment 19 placed in No. 4; died in three minutes.
 c No. 2 of Experiment 17 placed in No. 5; died in one minute.

No. 29. BROWN-SÉQUARD EXPERIMENT.

Commenced at 5.15 P.M., June 5, 1894. Mice in 7-litre bell jars. 5 in series.

Time.	No. 1. 11 g.		No. 2. 9 g.		No. 3. 12 g.		No. 4. 16 g.		No. 5. 19 g.		Remarks.
	CO ₂ .	O.	CO ₂ .	O.	CO ₂ .	O.	CO ₂ .	O.	CO ₂ .	O.	
16 hours.											121 litres aspirated. Current reduced; all are lively.
24											129 litres. Current increased; some oppression.
40½											301.5 litres. Current reduced.
47½											335.5 litres aspirated. Current increased; some oppression.
64½											451 litres. Current reduced.
70							10.51	11.80	7.45	5.80	
72½											460 litres. Current same; some oppression.
87½											535.5 litres. Current much reduced.
94½											541 litres. Current increased; greatly oppressed.
96½											545.5 litres. Current same.
113¾								+		+	Nos. 4 and 5 died in the night.
114											No. 1 of last experiment placed in jar No. 5; remained alive.
114								b			No. 2 of last experiment placed in jar No. 4; alive.
114											No. 3 of last experiment placed in jar No. 3; alive.
114½											565.5 litres aspirated.
115½											567 litres aspirated; all mice alive; experiment stopped.

NO. 30. BROWN-SÉQUARD EXPERIMENT.

Commenced at 1.15 P.M., June 13, 1894. Guinea-pigs in 7-litre bell jars. 5 in series.

Time.	No. 1.	No. 2.	No. 3.	No. 4.	No. 5.	Remarks.
	Wt. 172 g.	Wt. 185 g.	Wt. 197 g.	Wt. 275 g.	Wt. 287 g.	
3 hours.						Nos. 4 and 5 are oppressed. Current 24 litres per hour.
18½					+	No. 5 dead. Great negative pressure. Fresh air supplied, and No. 5 replaced by a fresh guinea-pig. Experiment continued.
21¾					Wt. 555	60 litres per hour; all are lively.
44¼					g.	Animals fed; bell jars cleaned. Animals replaced.
51¾						Animals fed; all well and dry; 60 litres per hour.
75¾						Again fed; all lively and dry in bottom of cages.
94¼						30 litres per hour; Nos. 4 and 5 oppressed; animals fed.
115¾						80 litres per hour; animals fed.
122¾						80 litres per hour; cages cleaned; animals fed.
139						40 litres per hour; animals fed; all oppressed.
148¼						50 litres per hour; animals fed.
163¾						50 litres per hour; animals fed.
171¾						45 litres per hour; animals fed.
187¾						No. 1 dead of œdema of lungs; experiment continued with 4 animals.
194¾	+					No. 3 died in night of œdema of lungs. Experiment continued.
211¾			+			Nos. 2, 4, and 5 living, but much oppressed. Experiment stopped.
235¾						

Experiment lasted 9 days and 20 hours. No. 5 died three days after close of experiment. No autopsy.

No. 33. BROWN-SÉQUARD EXPERIMENT.

Commenced at 2.45 P.M., December 8, 1894. Rabbits in 37-litre bell jars. 6 in series.

Time. Days.	No. 1. 820 g.		No. 2. 900 g.		No. 3. 917 g.		No. 4. 1125 g.		No. 5. 1220 g.		No. 6. 1665 g.		Remarks.
	CO ₂ . %	O. %	CO ₂ . %	O. %	CO ₂ . %	O. %	CO ₂ . %	O. %	CO ₂ . %	O. %	CO ₂ . %	O. %	
2									3.01	16.03	3.63	14.62	80 litres per hour aspirated.
3									3.43	15.39	4.32	13.86	70 litres per hour aspirated.
4													Larger glass tubing used to connect the bell jars. 100 litres per hour aspirated.
5									1.39	16.68	1.61	15.51	
6									1.58	16.27	1.72	14.49	
7									4.94	14.43	4.88	13.86	
8									4.31	15.29	4.46	14.98	
9									4.31	15.29	4.46	14.98	Cages cleaned out; 148 litres per hour aspirated.
10									2.51	16.69	2.72	15.69	
11													
12									1.08	16.38	1.59	16.30	130 litres per hour aspirated.
13									2.37	16.11	2.51	15.54	
14									1.69	16.60	1.99	15.43	
15													
16									1.75	16.55	2.23	15.67	Cages cleaned out.
17													
18									4.07	15.22	5.24	13.88	
19									4.69	15.15	5.53	13.74	
20									4.91	16.01	6.16	15.46	
21									4.51	15.58	5.85	14.00	
22													
23									7.61	11.81	7.75	11.63	Cages cleaned out; 130 litres per hour aspirated.
24									4.88	15.03	6.32	13.63	
25									5.58	14.20	6.52	13.35	120 litres per hour aspirated.
26									5.38	14.18	6.31	12.73	
27									6.84	14.00	6.51	14.11	125 litres per hour aspirated.
28									6.68	13.26	6.69	13.00	
29													
30									6.26	13.71	7.44	12.53	
31							4.89	14.87			7.11	12.74	
32							4.77	15.38			7.59	12.62	
33									6.39	13.37	7.81	11.77	110 litres per hour aspirated.
34											7.46	11.14	
35					4.23	15.76			5.74	14.17	8.02	11.69	Cages cleaned out; No. 6 not well; due to filth.
36													
37									6.67	13.55	7.70	12.45	No. 6 has fully recovered.
38									4.42	14.44	5.44	13.06	110 litres per hour aspirated.
39									5.29	13.51	6.81	12.05	
40					4.86	14.88					7.90	12.54	
41													
42									5.74	14.45	6.94	13.19	Experiment stopped.
		1052 g.		1055 g.		1190 g.		1047 g.		1352 g.		1544 g.	Weight of animal at close of experiment.

INDEX.

<p>Abbott, A. C. 14, 31</p> <p>Abbott's modification of Hammond apparatus 46</p> <p>Absorption tubes 57</p> <p>Air, expired, micro-organisms in 13, 33</p> <p> " " organic matter in . . . 4, 5, 8, 11, 14, 34</p> <p> oxidizable matter in 42</p> <p>Ammonia in condensed moisture from expired air 36</p> <p> in air 16</p> <p>Animals, individual susceptibility of 22</p> <p>Apparatus for condensing moisture 35, 38</p> <p>Appendix 33</p> <p>Asphyxia, composition of air producing . . . 17</p> <p> " pathology of 23</p> <p>Atmospheres, artificial 50</p> <p>Bacteria in hospital air 40</p> <p>Bergey's experiments 13, 33</p> <p>Bernard, C. 3</p> <p>Bert, Paul 3, 29</p> <p>Beu, J. 11, 15, 31</p> <p>Bibliography 29</p> <p>Black Hole of Calcutta 2</p> <p>Blood-counts 59</p> <p>Brown-Séguard apparatus 56</p> <p> " and d'Arsonval 5, 7, 13</p> <p> experiments 60</p> <p>Bunte's gas burette 44</p> <p>Carbonic acid, effects of 2, 4, 17, 47</p> <p>Conclusions 24</p> <p>Condensing apparatus 38</p> <p>Consumption, causes of 26</p> <p>Dastre and Loye 6, 30</p> <p>Dust filter 16, 39</p> <p>Fasting, effects of, on expired air 15</p> <p>Friedländer and Herter 19, 29, 31</p> <p>Gaseous mixtures 18</p> <p>Habit, effects of 19, 25</p> <p>Haldane and Smith 9, 11, 30</p> <p>Hammond, W. A. 4, 29</p> <p> " experiments 42</p> <p>Hermans, J. T. F. 5, 29</p> <p>Hospital ward, air of 39</p>	<p>Injections of liquid condensed from exhaled air 5, 7, 8, 10, 20, 53</p> <p>Leblanc's researches</p> <p>Lehmann and Jessen 8, 15, 30</p> <p>Lipari and Crisafulli 9, 30</p> <p>Lübbert and Peters 12, 34</p> <p>Margouty, B. M. E. 9, 30</p> <p>Merkel, S. 10, 30</p> <p>Micro-organisms in expired air 13, 33</p> <p>Moisture of exhaled air 5, 15, 34</p> <p>Mouth, cleansing of, effects of 37</p> <p> " decomposing organic matters in . . . 15</p> <p>Negative pressure 58</p> <p>Odors, cause of 26</p> <p>Olmsted, Dr. Ingersoll</p> <p>Organic matter in human breath 4, 37</p> <p>Oxygen, diminution of, effects of 18</p> <p>Pettenkofer, M. 3, 29</p> <p>Pulmonary liquid, injection of 6</p> <p>Ransome, A. 4, 15, 29</p> <p>Rauer 12, 32</p> <p>Regnault and Reiset 3, 29</p> <p>Renk, F. 15, 31</p> <p>Richardson, B. W. 3, 19, 29</p> <p>Richardson's experiment 48</p> <p>Russo-Giliberti and Alessi 7, 30</p> <p>Sanfelice, F. 12, 31</p> <p>Seegen and Nowak 5, 29</p> <p>Smith, R. A. 4, 29</p> <p>Temperature, effects of 25</p> <p>Toleration of foul air, acquired 19</p> <p>Uffelmann, J. 8, 30</p> <p>Valentin, G. 3, 29</p> <p>Ventilation, insufficient, effects of 2, 60</p> <p>Von Hofmann-Wellenhof 8</p> <p>Warwick, Dr. Hill S.</p> <p>Weight of animals, effect of breathing expired air on 58</p> <p>Würtz, R. 7, 30</p>
---	---

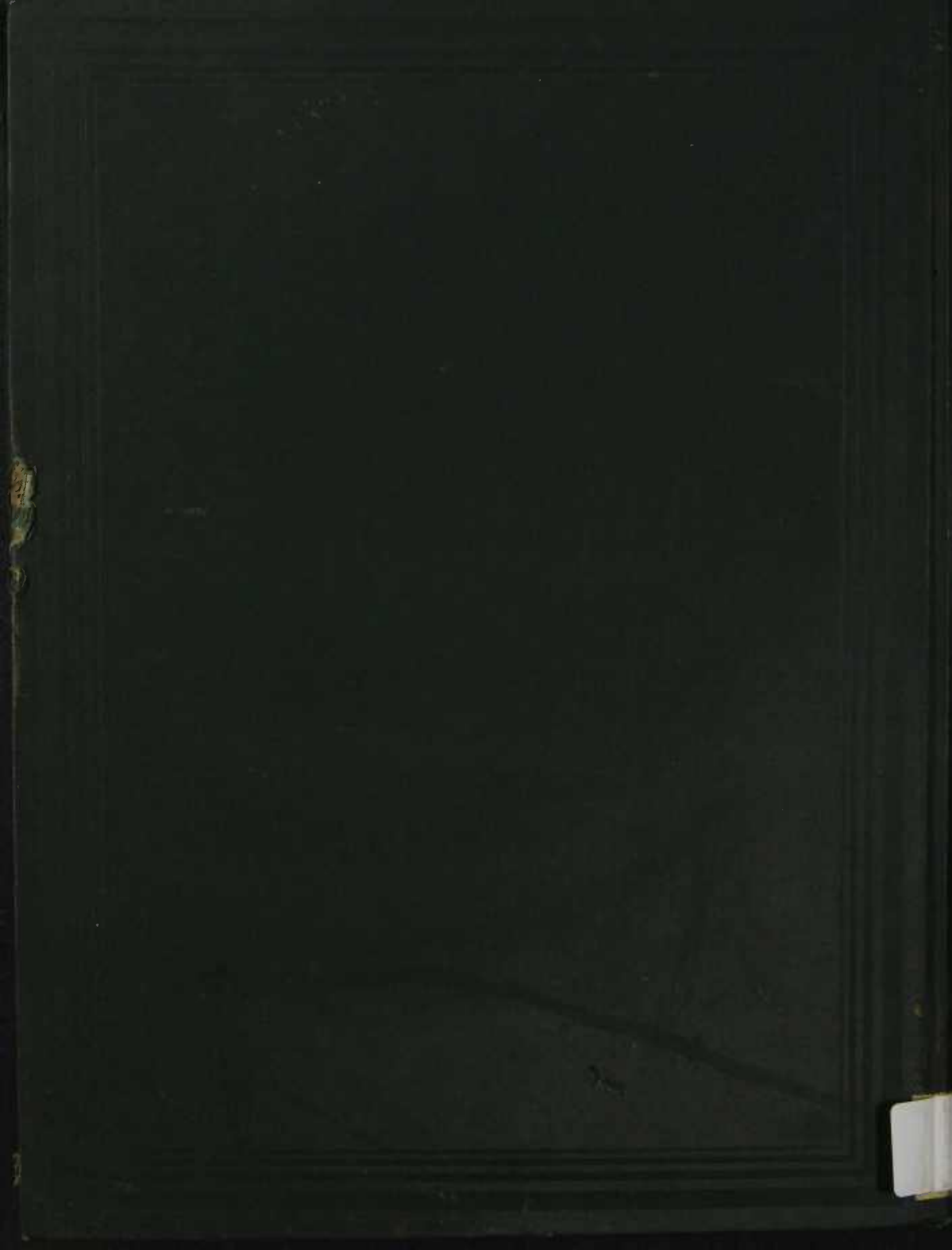

ORIENTAÇÕES PARA O USO

Esta é uma cópia digital de um documento (ou parte dele) que pertence a um dos acervos que fazem parte da Biblioteca Digital de Obras Raras e Especiais da USP. Trata-se de uma referência a um documento original. Neste sentido, procuramos manter a integridade e a autenticidade da fonte, não realizando alterações no ambiente digital – com exceção de ajustes de cor, contraste e definição.

1. Você apenas deve utilizar esta obra para fins não comerciais. Os livros, textos e imagens que publicamos na Biblioteca Digital de Obras Raras e Especiais da USP são de domínio público, no entanto, é proibido o uso comercial das nossas imagens.

2. Atribuição. Quando utilizar este documento em outro contexto, você deve dar crédito ao autor (ou autores), à Biblioteca Digital de Obras Raras e Especiais da USP e ao acervo original, da forma como aparece na ficha catalográfica (metadados) do repositório digital. Pedimos que você não republique este conteúdo na rede mundial de computadores (internet) sem a nossa expressa autorização.

3. Direitos do autor. No Brasil, os direitos do autor são regulados pela Lei n.º 9.610, de 19 de Fevereiro de 1998. Os direitos do autor estão também respaldados na Convenção de Berna, de 1971. Sabemos das dificuldades existentes para a verificação se uma obra realmente encontra-se em domínio público. Neste sentido, se você acreditar que algum documento publicado na Biblioteca Digital de Obras Raras e Especiais da USP esteja violando direitos autorais de tradução, versão, exibição, reprodução ou quaisquer outros, solicitamos que nos informe imediatamente (dtsibi@usp.br).